

INSTALLATION MANUAL

10112Z

ecolight



98mm

230V | 12W | IP20 | Die cast + plastic reflector

Complete with 300mA driver.

80 CRI

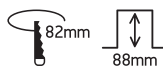

68mm

one
LIGHT

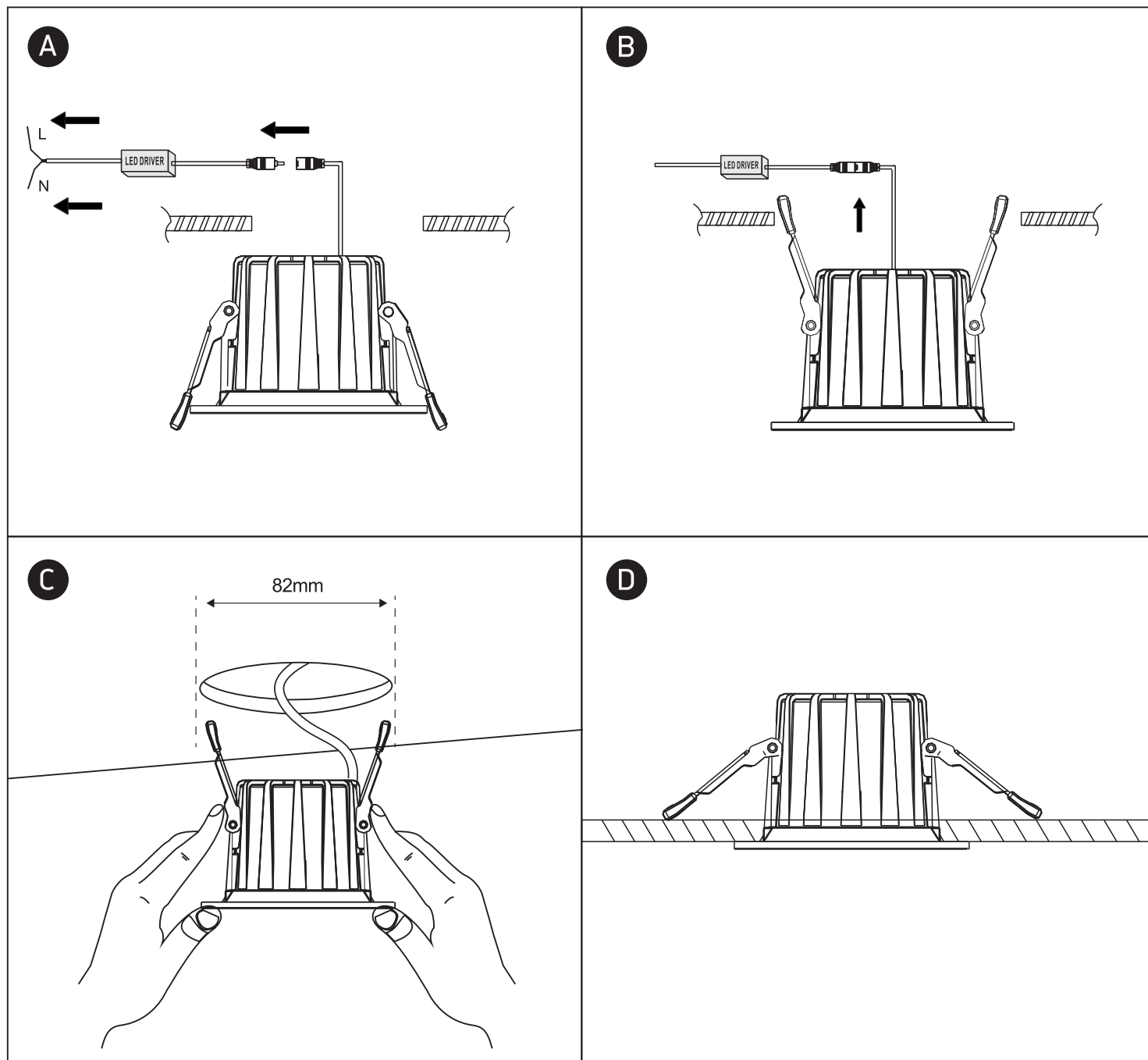

Warnings:

1. Make sure that the product is installed properly before connecting to electricity.
2. Do not cover the fitting.
3. Maintenance and installation should only be carried out by a professional electrician.