

INSTALLATION MANUAL

10130CA

ecodownlight



CE

RoHS
COMPLIANT



NOT
DIMMABLE

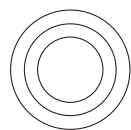

230mm

230V | 30W | IP20 | Die cast

Complete with driver.

80
CRI

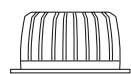

110mm

one
LIGHT

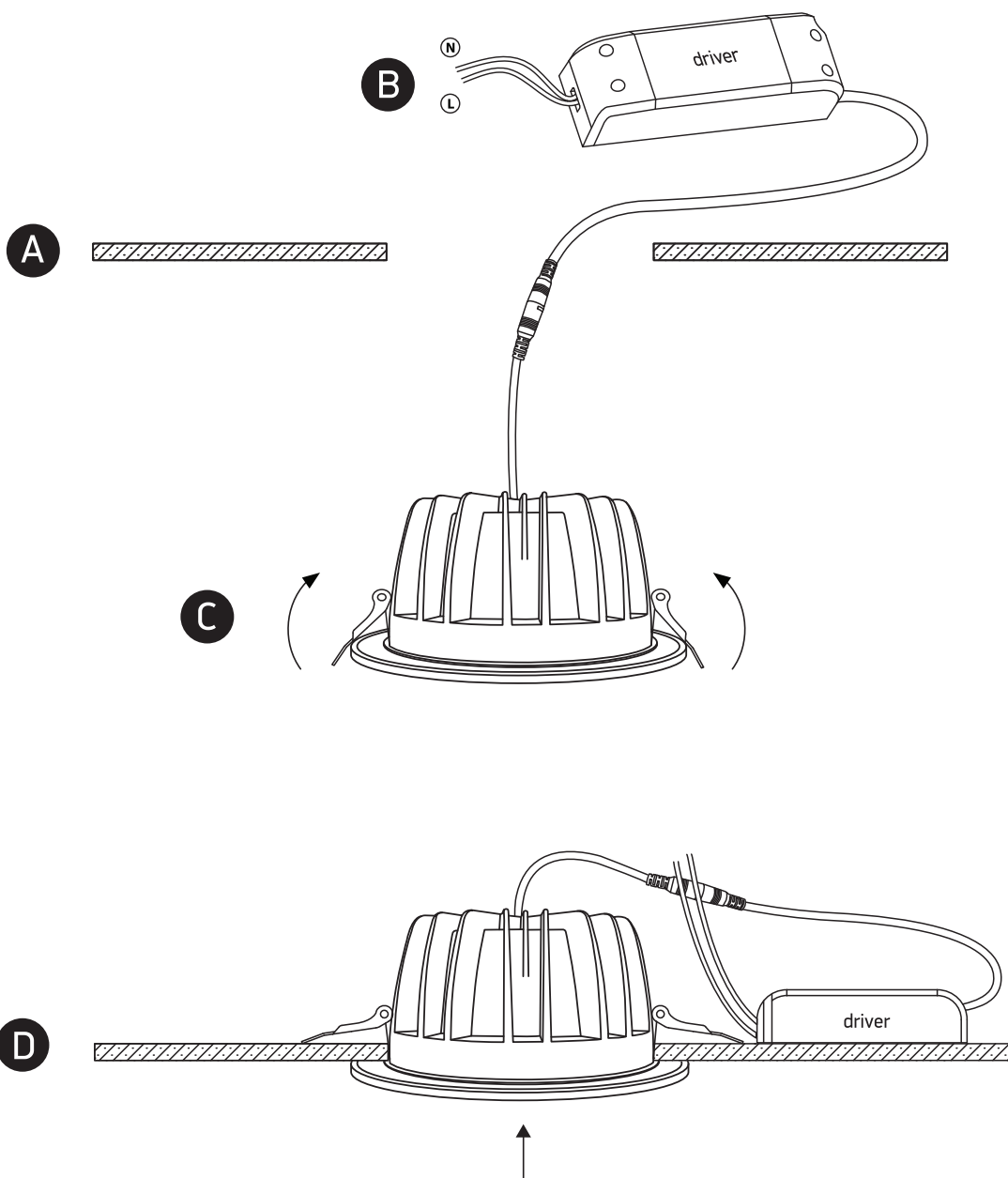

Warnings:

1. Make sure that the product is installed properly before connecting to electricity.
2. Do not cover the fitting.
3. Maintenance and installation should only be carried out by a professional electrician.