

INSTALLATION MANUAL

11103B

ecolight



90 CRI



350mA/700mA | 1W/3W | IP20 | Aluminium | Adjustable

For 1W use 350mA driver / For 3W use 700mA driver.

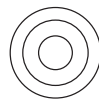

52mm

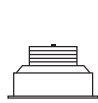

36mm



45mm



60mm



40cm

one
LIGHT

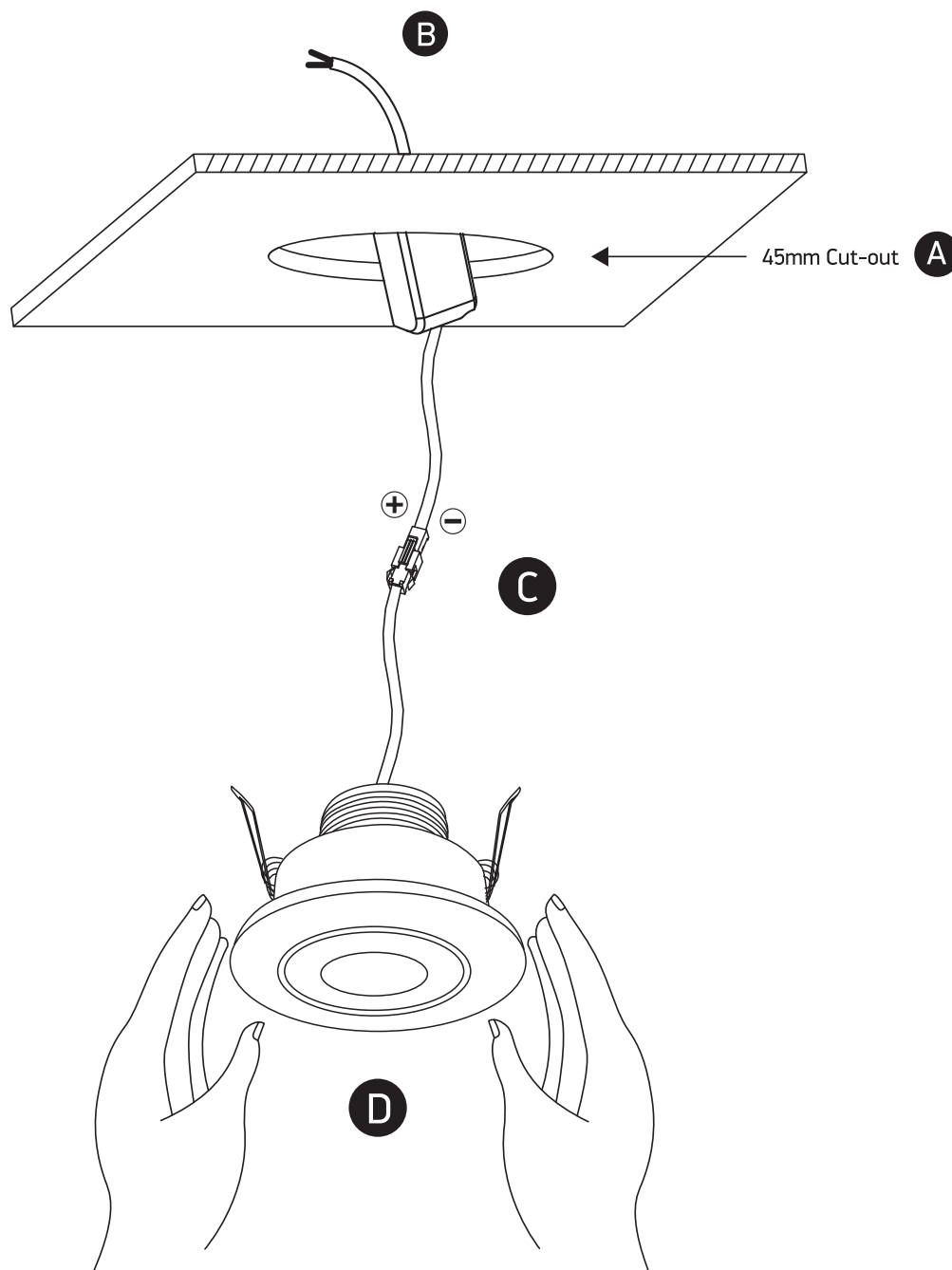

Warnings:

1. Make sure that the product is installed properly before connecting to electricity.
2. Do not cover the fitting.
3. Maintenance and installation should only be carried out by a professional electrician.