











INSTALLATION MANUAL

11110F

ecodownlight	  	 ADJUSTABLE	   	 108mm	
230V 10W IP20 Die cast	Complete with driver	 90mm	 105mm	80 CRI	 76mm

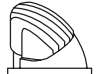

A

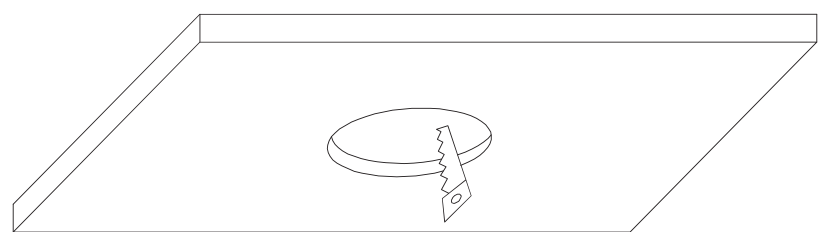

CUTOUT HOLE: 90mm

B

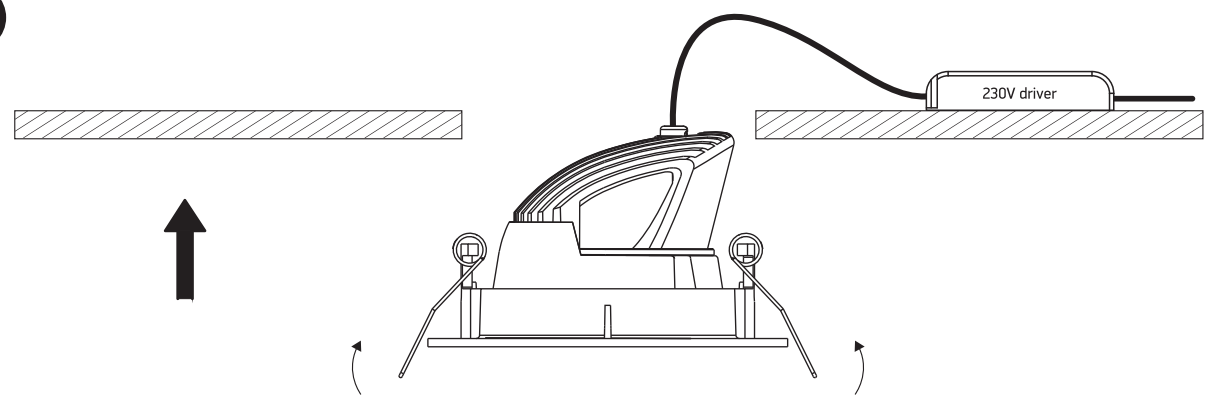

C

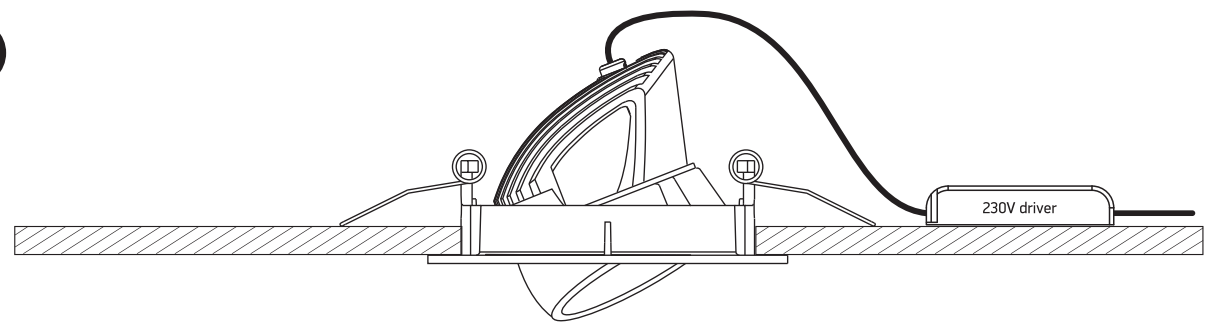

Warnings:

1. Make sure that the product is installed properly before connecting to electricity.
2. Do not cover the fitting.
3. Maintenance and installation should only be carried out by a professional electrician.