

# INSTALLATION MANUAL

12120ZA

**ecolight**



DARK LIGHT

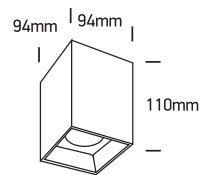

230V | 20W | IP20 | Die cast + plastic reflector

Complete with driver.

80 CRI



**one**  
LIGHT

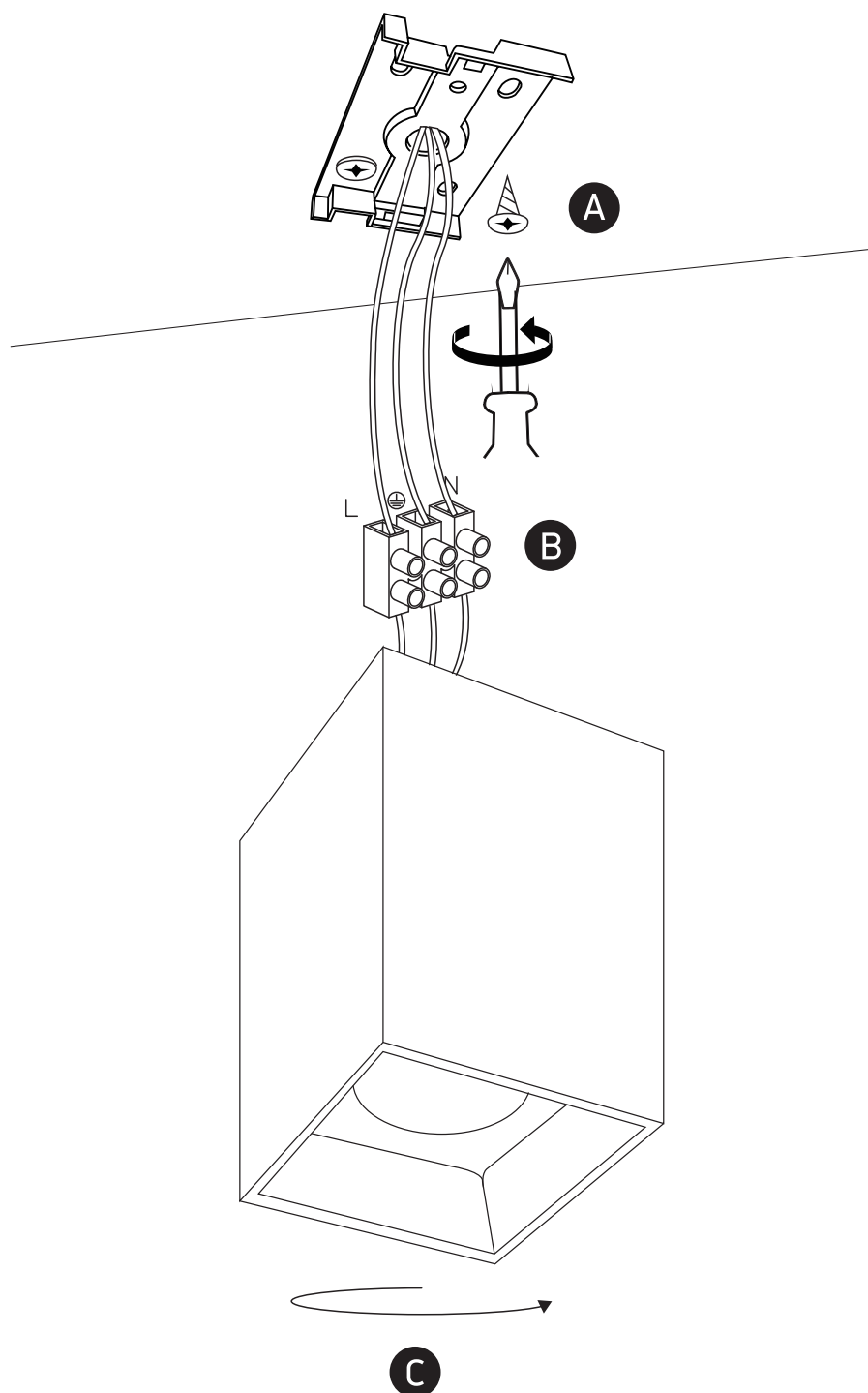

## Warnings:

1. Make sure that the product is installed properly before connecting to electricity.
2. Do not cover the fitting.
3. Maintenance and installation should only be carried out by a professional electrician.