

Artikel Nr.: 732125

Boden-/Wand-/Deckenleuchte, Colt 25W RGBW, Schwarzgrau RAL 7021, 24V DC, RGB + Kaltweiß

Technische Daten

Charakteristik

Material	Aluminium Druckguss
Farbe	Schwarzgrau RAL 7021
Optik	
im Lieferumfang	2 Gläser (transparent/milchig) 1 Wabenfilter 2 Sechskantschlüssel



Elektrische Daten

Leistung	25,00 W
Eingangsspannung	24V DC
Eingangsstrom	
Fassung / Sockel	
Anzahl Sockel	
Netzgerät	exkl. LED-Netzgerät
Ansteuerung	nicht dimmbar
Anschlussmöglichkeit	Klemme
Schutzklasse I, II, III	III

Lichttechnische Eigenschaften

Leuchtmittel	Lichtquelle fest
Lichtfarbe	RGB + Kaltweiß
Farbtemperatur	5500 K
Lichtstrom	1445 lm
Abstrahlwinkel	20°
LED Typ	SMD 4in1
LED Anzahl	1
Strahlungsverteilung	455-625 nm



Artikel Nr.: 732125

Boden-/Wand-/Deckenleuchte, Colt 25W RGBW, Schwarzgrau RAL 7021, 24V DC, RGB + Kaltweiß

Lichtrichtung

Dreh- und Schwenkbereich	dreh-schwenkbar
Neigungswinkel	180°
Abstrahlverhalten	
Reflektor / Linse	symmetrisch

Abmessungen und Gewicht

Länge	0,00
Breite	0,00
Höhe	112,00
Durchmesser	131,00
Gewicht	1983 g

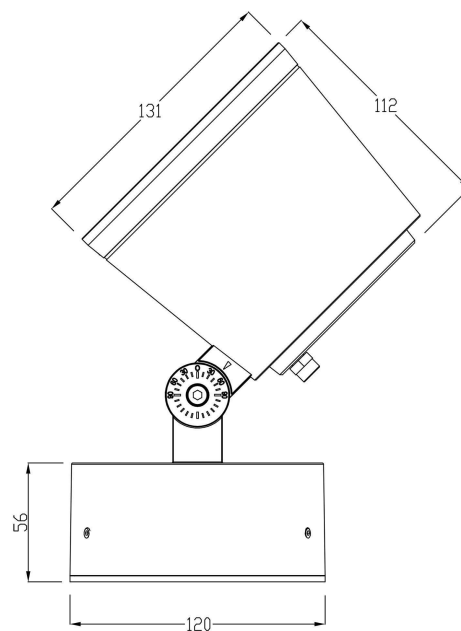

Grenzwerte

Betriebstemperatur	-30°C - +40°C
Lagertemperatur	-40°C - +80°C
IP - Schutzart	IP65

Artikel Nr.: 732125

Boden-/Wand-/Deckenleuchte, Colt 25W RGBW, Schwarzgrau RAL 7021, 24V DC, RGB + Kaltweiß



Allgemeine Eigenschaften

Umwelteigenschaften

Energieeffizienzklasse	G
Energieverbrauch	25 kWh/1000h

Lebensdauer

Lebensdauer	50000 h
Lichtstrom Ende Lebensdauer	0,70
Schaltzyklen	15000

EEL	Dieses Produkt enthält eine Lichtquelle der Energieeffizienzklasse G
IP65	Schutz gegen das Eindringen von Staub. (Staubdicht) Geschützt gegen Strahlwasser.
	Leuchte der Schutzklasse III Leuchte, bei der der Schutz gegen elektrischen Schlag auf der Anwendung der Schutzkleinspannung (SELV) beruht und in der Spannungen höher als SELV nicht erzeugt werden.
	Aufgrund des komplexen Herstellungsprozesses von LED stellen die angegebenen Werte nur rein statistische Größen dar und müssen nicht zwingend den tatsächlichen Parametern jedes einzelnen LED-Moduls entsprechen, sondern können von den typischen Werten abweichen.

Article no.: 732125

Ground- / Wall- / Ceiling lamp, Colt 25W RGBW, Black grey RAL 7021, 24V DC, RGB + coldwhite

Technical Data
General Characteristics

Material	aluminum die casting
Colour	Black grey RAL 7021
Optics	
included in delivery	2 glasses (transparent/milky) 1 honeycob filter 2 allen wrench

Electrical Characteristics

Power	25,00 W
Input Voltage	24V DC
Input current	
Base (standard designation)	
Number of Bases	
Power supply unit	excl. LED-power supply unit
Electronically reversible	not dimmable
Connection possibility	clamp
Protection class I, II, III	III

Light Technical Data

Bulb	Lichtquelle fest
Colour Designation	RGB + coldwhite
Colour temperature	5500 K
Luminous flux	1445 lm
Beam angle	20°
LED type	SMD 4in1
LED quantity	1
Spectral power distribution	455-625 nm



Article no.: 732125

Ground- / Wall- / Ceiling lamp, Colt 25W RGBW, Black grey RAL 7021, 24V DC, RGB + coldwhite

Light Direction

Rotating and tilting range	swivel
Angle of inclination	180°
Radiation direction	
Reflector / lense	symmetrisch

Dimensions & Weight

Length	0,00
Width	0,00
Height	112,00
Diameter	131,00
Product Weight	1983 g

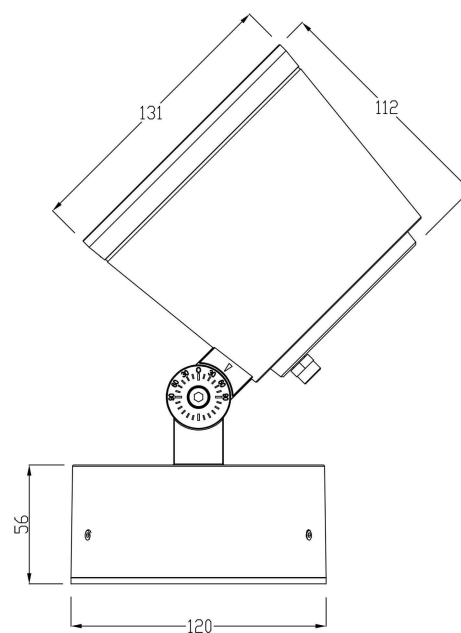
Absolute maximum ratings

Working temperature	-30°C - +40°C
Storage temperature	-40°C - +80°C
IP - Code	IP65

Article no.: 732125



Ground- / Wall- / Ceiling lamp, Colt 25W RGBW, Black grey RAL 7021, 24V DC, RGB + coldwhite

Environmental Characteristics

Energy label	G
Energy consumption	25 kWh/1000h

Lifespan

Lamp life time	50000 h
Luminous flux (end of lifetime)	0,70
Number of switching cycles	15000

EEL	This product contains a light source of energy efficiency class G
IP65	Protection against penetration of dust. (complete dust protection) Protection against penetration of water jets.
	Lightings of Protection Class III Luminaire in which protection against electric shock relies on supply at safety extra-low voltage (SELV) and in which voltages higher than those of SELV are not generated.
	Because of the complex manufacturing process of the LED the above shown data are just a statistical size, which is not forced to be the realistic data of every LED.