

## PRODUCT DESCRIPTION

A head for mounting lightweight lighting fixtures on wall arms mounted directly to the extrusion

Fill empty fields

Product nr.  
Fixture type  
Company  
Job name  
Date



## TECHNICAL SPECIFICATION

## TECHNICAL DRAWING

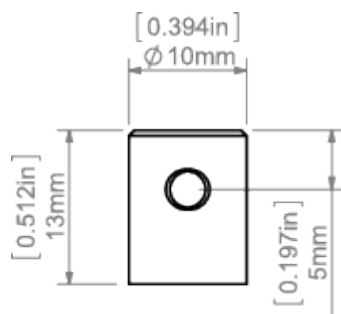

**RELATED PROFILES**

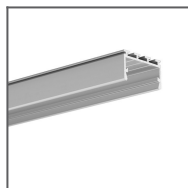

GIZA-LL profile  
Ref: C0758

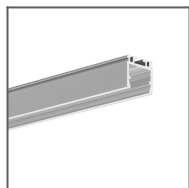

OPK-4 Profile  
Ref: C0370

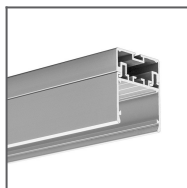

3035 Profile  
Ref: 18039

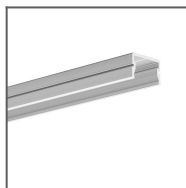

SILER Profile  
Ref: B9325

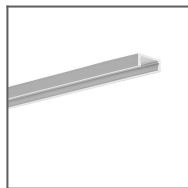

MICRO-ALU Profile  
Ref: B1888

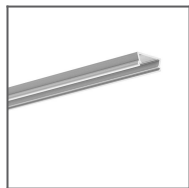

TAMI Profile  
Ref: B5390

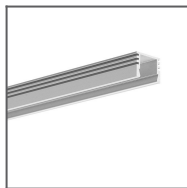

PDS-4-ALU Profile  
Ref: B1718

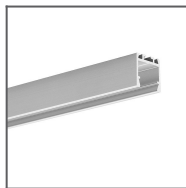

PDS-ZM Profile  
Ref: B7696

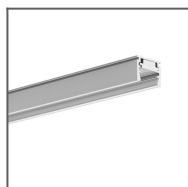

REGULOR Profile  
Ref: B468+43

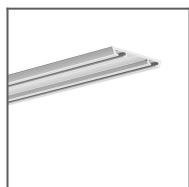

TEST-36 Profile  
Ref: B6639

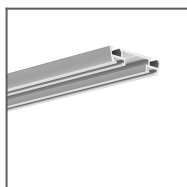

TEST-74 Profile  
Ref: W4507

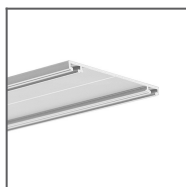

TETRA-43 Profile  
Ref: W4476

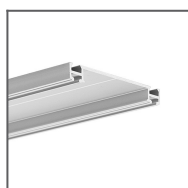

TETRA-78 Profile  
Ref: W4508

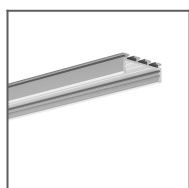

GIZA Profile  
Ref: B5556

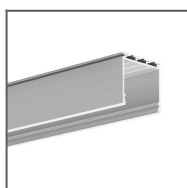

LIPOD Profile  
Ref: B5554

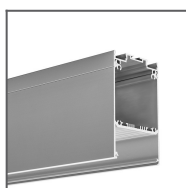

DES Profile  
Ref: 18030

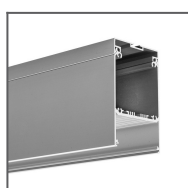

GLADES Profile  
Ref: 18036

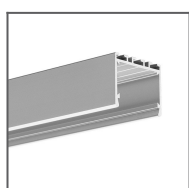

3035-O Profile  
Ref: B8441

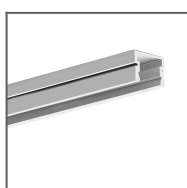

PDS-4-PLUS  
Profile  
Ref: C1263

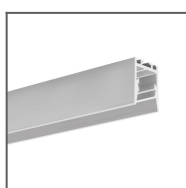

PDS-ZMG Profile  
Ref: C1418

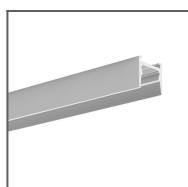

MICRO-HG Profile  
Ref: C1419

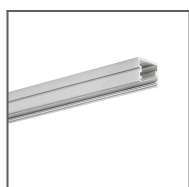

TAPO Profile  
Ref: C1919

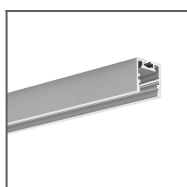

PDS-ZM-PLUS  
Profile  
Ref: C2056

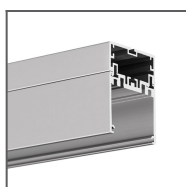

4050 Profile  
Ref: 18050

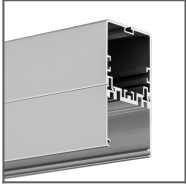

4050-W Profile  
Ref: 18051

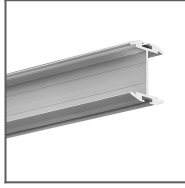

GIZA-DUO-LL  
Profile  
Ref: C2162

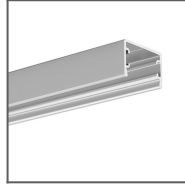

GLAZA-LL Profile  
Ref: C2627

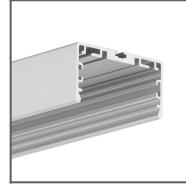

LIPOD-50 Profile  
Ref: C2609

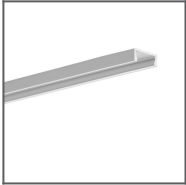

MICRO-PLUS  
Profile  
Ref: C2966

**RELATED PRODUCTS**

**ACCESSORIES**

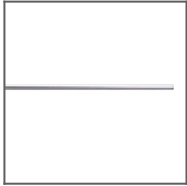

K0-AB Arm  
Ref: 42101

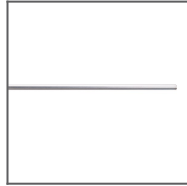

K0-AB300 Arm  
Ref: 42202

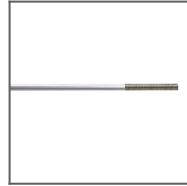

K0G-AB Arm  
Ref: 42102

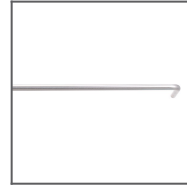

K1-AB Arm  
Ref: 42113

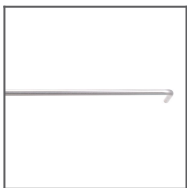

K1-AB300 Arm  
Ref: 42201

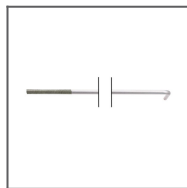

K1G-AB Arm  
Ref: 42115

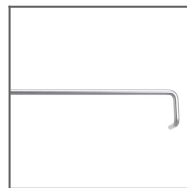

K2-AB Arm  
Ref: 42114

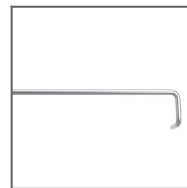

K2-AB300 Arm  
Ref: 42200



K2G-AB Arm  
Ref: 42116



K5G-AB Arm  
Ref: 42051

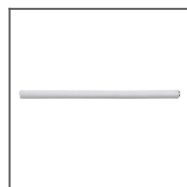

M5-K5 Rod 1m  
Ref: 42209