

## PRODUCT DESCRIPTION

- Installation of lighting and stretch films in suspension
- High lumen output
- Mounting to 12 mm | 0.47" drywall
- Non visible aluminum elements
- Line of light flush with the surface

### FINISH :

Non anodized (raw) 

\*Custom colors available upon request

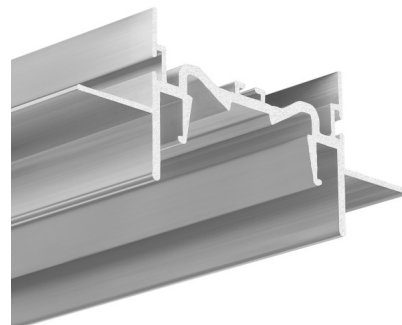

Fill empty fields

Product nr.

Fixture type

Company

Job name

Date

## TECHNICAL SPECIFICATION

### Application

- lighting recessed in surfaces made of stretch film and in drywall

### Mounting

- suspended or in drywall, using a dedicated mounting track, dedicated accessories and screws
- can be easily connected into runs
- the cover is cut to the length of the profile

### Additional information

- the profile has grooves for the attachment of the hooks from the stretch film

## AVAILABLE LENGTHS

| Ref. nr.  | surface finish     | available lengths |
|-----------|--------------------|-------------------|
| C3632NA_1 | Non anodized (raw) | 1000 mm           |
| C3632NA_2 | Non anodized (raw) | 2000 mm           |
| C3632NA_3 | Non anodized (raw) | 3000 mm           |

**TECHNICAL DRAWING**

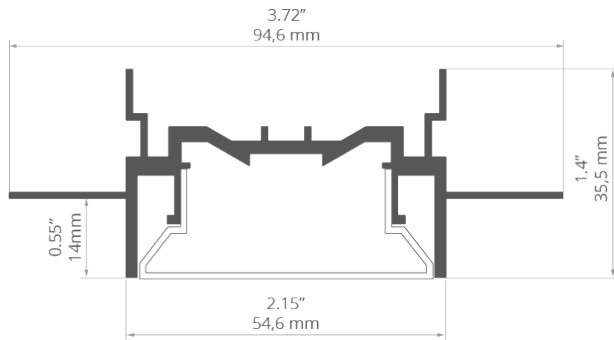

RELATED PROFILES

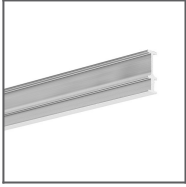

FOLHAK Profile  
Ref: B8338

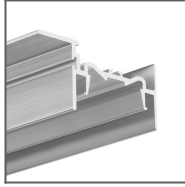

FOLED-50-SUF  
Profile  
Ref: C3631

## RELATED PRODUCTS

### COVERS

#### FROSTED COVERS

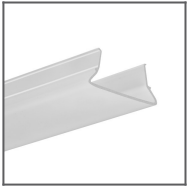

FOLED-50 frosted  
Cover  
Ref: 17171

### END CAPS

#### REGULAR END CAPS



FOLED-50-W End  
cap  
Ref: 24294

### STEEL



FOLED-50 End  
cap  
Ref: 42676

### ACCESSORIES

#### FASTENERS & MOUNTING ACCESSORIES



Spring hanger  
Ref: 79106

COMPONENTS FOR CONNECTING PROFILES

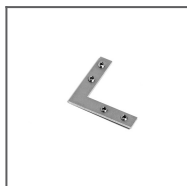

ZM-NA-90  
Connector  
Ref: 42723

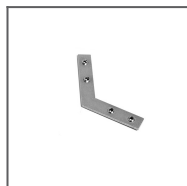

ZM-NA-120  
Connector  
Ref: 42729

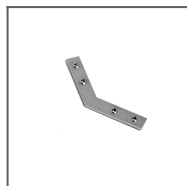

ZM-NA-135  
Connector  
Ref: 42725

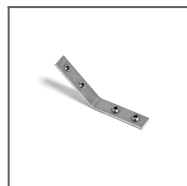

ZM-NA-PION-135  
Connector  
Ref: 42727

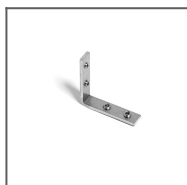

ZM-NA-PION-90  
Connector  
Ref: 42726

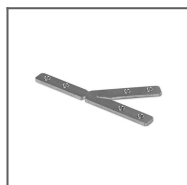

ZM-T45-G  
Connector  
Ref: 42324

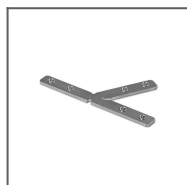

ZM-T60-G  
Connector  
Ref: 42326

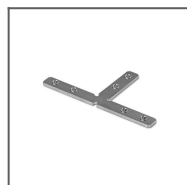

ZM-T90-G  
Connector  
Ref: 42328

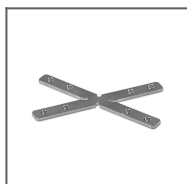

ZM-X60-G  
Connector  
Ref: 42332

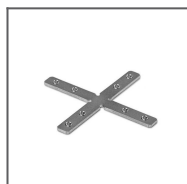

ZM-X90-G  
Connector  
Ref: 42334

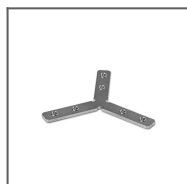

ZM-Y120-G  
Connector  
Ref: 42336

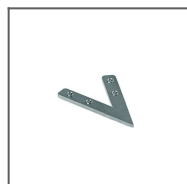

ZM-NA-45  
Connector  
Ref: 42339



ZM-NA-PION-120  
Connector  
Ref: 42321

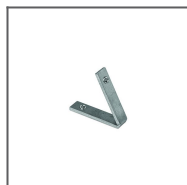

ZM-NA-PION-60  
Connector  
Ref: 42317



ZM-NA-PION-45  
Connector  
Ref: 42315

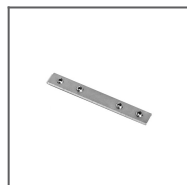

ZM-NA-180  
Connector  
Ref: 42724

SEALING COMPONENTS



6 x 1.2 Gland  
Ref: 00802