

PRODUCT DESCRIPTION

- Installation of lighting and stretch films in suspension
- Mounting to 12 mm / 0.47" drywall boards
- Non visible aluminum elements
- Line of light flush with the surface

FINISH :

Non anodized (raw) 

*Custom colors available upon request

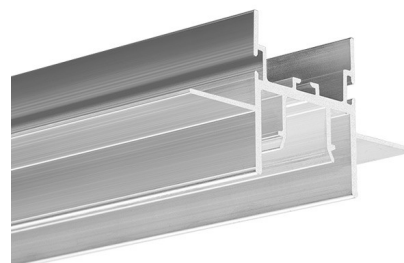

Fill empty fields

Product nr.

Fixture type

Company

Job name

Date

TECHNICAL SPECIFICATION

Application

- lighting recessed in surfaces made of stretch film and in drywall.

Mounting

- suspended or in drywall, using a dedicated mounting track, dedicated accessories and screws,
- can be easily connected into runs,
- the cover is cut to the length of the profile.

Additional information

- the profile has grooves for the attachment of the hooks from the stretch film.

AVAILABLE LENGTHS

Ref. nr.	surface finish	available lengths
B8332V1NA_1	Non anodized (raw)	1000 mm
B8332V1NA_2	Non anodized (raw)	2000 mm
B8332V1NA_3	Non anodized (raw)	3000 mm

TECHNICAL DRAWING

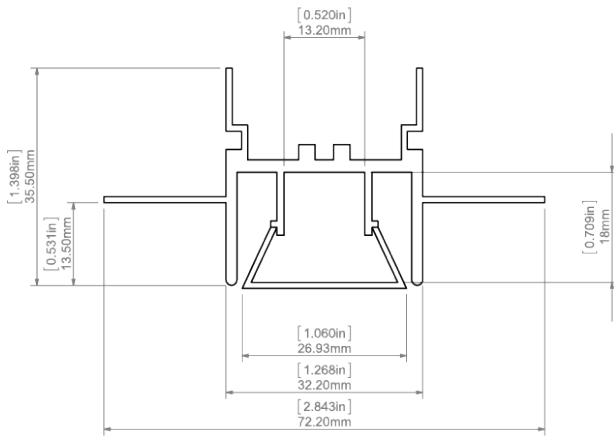

RELATED PROFILES

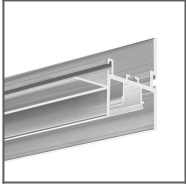

FOLED-BOK
Profile
Ref: B8334V1

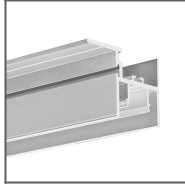

FOLED-SUF Profile
Ref: B8333V1

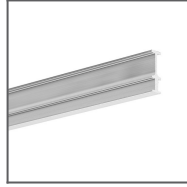

FOLHAK Profile
Ref: B8338

RELATED PRODUCTS

COVERS

BLACK COVERS

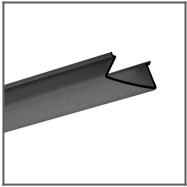

FOLED black Cover
Ref: 17045

80°



FROSTED COVERS



FOLED frosted
Cover
Ref: 17077V1



FOLED frosted Cover
Ref: 17047

100°



END CAPS

REGULAR END CAPS



FOLED-W black
End cap
Ref: 24285

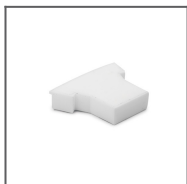

FOLED-W white
End cap
Ref: 24277

STEEL



FOLED End cap
Ref: 42652

ACCESSORIES

FASTENERS & MOUNTING ACCESSORIES



Spring hanger
Ref: 79106

COMPONENTS FOR CONNECTING PROFILES

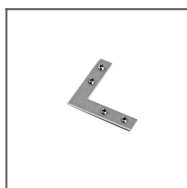

ZM-NA-90
Connector
Ref: 42723

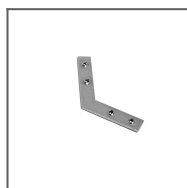

ZM-NA-120
Connector
Ref: 42729

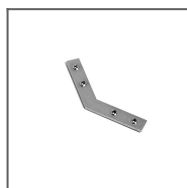

ZM-NA-135
Connector
Ref: 42725

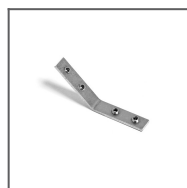

ZM-NA-PION-135
Connector
Ref: 42727

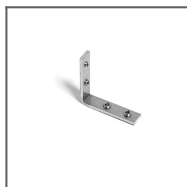

ZM-NA-PION-90
Connector
Ref: 42726

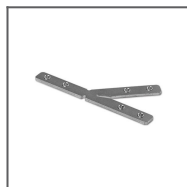

ZM-T45-G
Connector
Ref: 42324

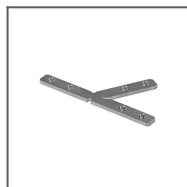

ZM-T60-G
Connector
Ref: 42326

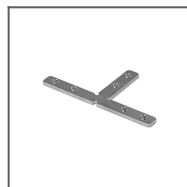

ZM-T90-G
Connector
Ref: 42328

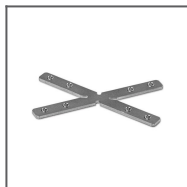

ZM-X60-G
Connector
Ref: 42332

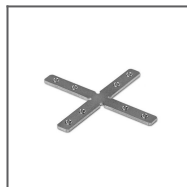

ZM-X90-G
Connector
Ref: 42334



ZM-Y120-G
Connector
Ref: 42336

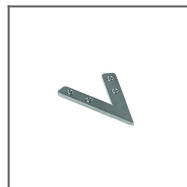

ZM-NA-45
Connector
Ref: 42339



ZM-NA-PION-120
Connector
Ref: 42321

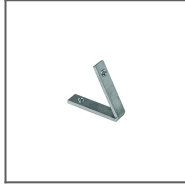

ZM-NA-PION-60
Connector
Ref: 42317

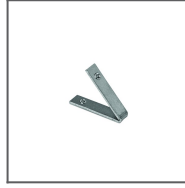

ZM-NA-PION-45
Connector
Ref: 42315

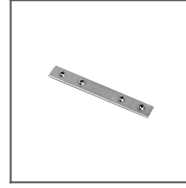

ZM-NA-180
Connector
Ref: 42724

SEALING COMPONENTS



6 x 1.2 Gland
Ref: 00802

MARKETING MATERIALS



Display
P230-90111M
Ref: 90111M



Presentation set 7
Ref: 90126