

PRODUCT DESCRIPTION

- Hallway lighting
- Designed for IP67 protection rating IP67
- Low height

FINISH :

Non anodized (raw) Silver anodized 

*Custom colors available upon request



Fill empty fields

Product nr.

Fixture type

Company

Job name

Date

TECHNICAL SPECIFICATION

Application

- warning and functional lighting.

Mounting

- in the ground, with mounting adhesive,
- the cover is cut to the length of the profile.

AVAILABLE LENGTHS

Ref. nr.	surface finish	available lengths
B1889NA_1	Non anodized (raw)	1000 mm
B1889NA_2	Non anodized (raw)	2000 mm
B1889NA_3	Non anodized (raw)	3000 mm
B1889ANODA_1	Silver anodized	1000 mm
B1889ANODA_2	Silver anodized	2000 mm
B1889ANODA_3	Silver anodized	3000 mm

TECHNICAL DRAWING

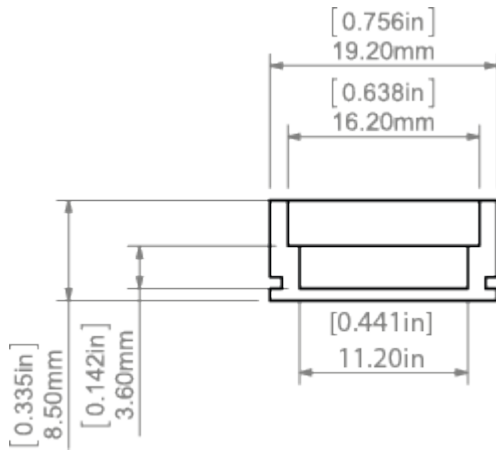

RELATED PRODUCTS

COVERS

FROSTED COVERS

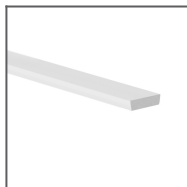

HR-ALU frosted Cover
Ref: 0945

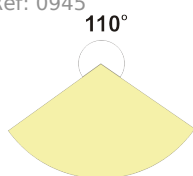

END CAPS

REGULAR END CAPS

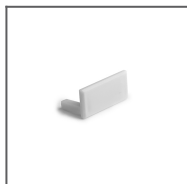

HR-ALU grey End
cap
Ref: 00010

REGULAR END CAPS WITH HOLE

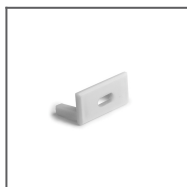

HR-ALU-OTW grey
End cap
Ref: 00347

ACCESSORIES

SEALING COMPONENTS



6 x 1.2 Gland
Ref: 00802

MARKETING MATERIALS



Presentation set 1
Ref: 90051

LED TAPES

WHITE

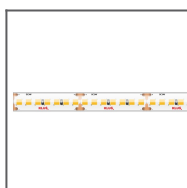

Taśma LED WP-K-1910-
HD-IP65-24V
Ref: WP-K-1910-HD-
IP65-24V

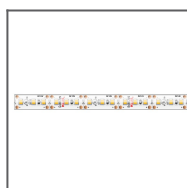

LED strip WP-
K-1220-IP65-12V
Ref: WP-K-1220-
IP65-12V

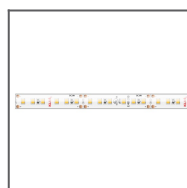

LED strip WP-
K-1220-IP65-24V
Ref: WP-K-1220-
IP65-24V