

PRODUCT DESCRIPTION

- Two lighting directions
- Wide lighting angle
- Lighting fixture with round cross-section
- Wide range of accessories

FINISH :

Silver anodized RAL

*Custom colors available upon request



Fill empty fields

Product nr.

Fixture type

Company

Job name

Date

TECHNICAL SPECIFICATION

Application

- main and decorative lighting.

Mounting

- suspended, using dedicated accessories.

Additional information

- a wide range of accessories that allows various mounting of the lighting fixture in any direction.

AVAILABLE LENGTHS

Ref. nr.	surface finish	available lengths
C0788ANODA_1	Silver anodized	1000mm
C0788ANODA_2	Silver anodized	2000mm
C0788ANODA_3	Silver anodized	3000mm
C0788L9010OD_2	White RAL	2000 mm

TECHNICAL DRAWING

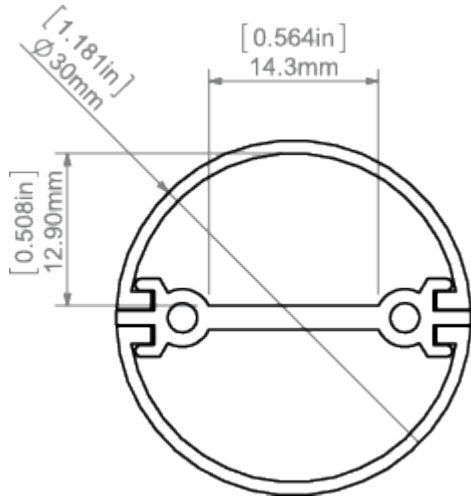

RELATED PRODUCTS

COVERS

FROSTED COVERS

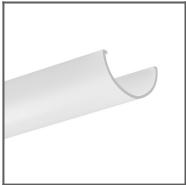

JAZ-DUO frosted
Cover
Ref: 17163

END CAPS

REGULAR END CAPS

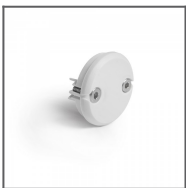

JAZ-DUO-N grey
End cap
Ref: 42641

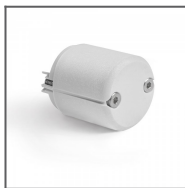

JAZ-DUO-W grey
End cap
Ref: 42642



JAZ-DUO-W white
End cap
Ref: 42660

REGULAR END CAPS WITH HOLE



JAZ-DUO-N-OTW
grey End cap
Ref: 42644



JAZ-DUO-N-FI-6,5
grey End cap
Ref: 42643

ELECTRICITY CONDUCTIVE END CAPS



JAZ-DUO-N grey
electricity
conductive End
cap
Ref: 42632

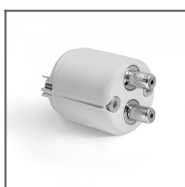

JAZ-DUO-W grey
electricity
conductive End
cap
Ref: 42633

ACCESSORIES

FASTENERS & MOUNTING ACCESSORIES



LIN Fastener
silver
Ref: 42294



Isolated CU cable
FI-1.35 mm
Ref: 70310

MOUNTING SETS



RG-1 Fastener set
black
Ref: 42647L9005



RG-1 Fastener set
silver
Ref: 42647NI

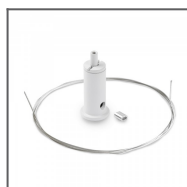

RG-1 Fastener set
white
Ref: 42647L9010



RG-1 Fastener set
silver satin
Ref: 42647GSS

SEALING COMPONENTS



6 x 1.2 Gland
Ref: 00802

MARKETING MATERIALS

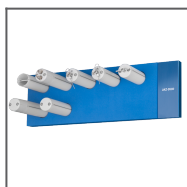

Foam 70342
Ref: 70342



Display
P230-90173M
Ref: 90173M