

PRODUCT DESCRIPTION

- Mounting to drywall boards
- Minimum height
- No collision with the ceiling structure
- Line of light flush with the surface
- Non visible aluminum elements

FINISH :

Non anodized (raw) 

*Custom colors available upon request

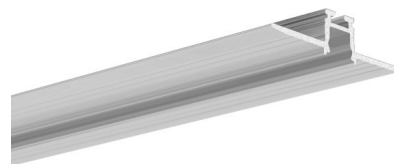

Fill empty fields

Product nr.

Fixture type

Company

Job name

Date

TECHNICAL SPECIFICATION

Application

- decorative lighting i funkcyjne.

Mounting

- in drywall, with mounting adhesive,
- can be easily connected into runs,
- the cover is cut to the length of the profile.

Additional information

- in order to protect the lighting fixture during installation, a TECH-10 protective insert should be used,
- smooth transition from a recessed into a suspended lighting fixture possible.

AVAILABLE LENGTHS

Ref. nr.	surface finish	available lengths
C1575NA_1	Non anodized (raw)	1000 mm
C1575NA_2	Non anodized (raw)	2000 mm
C1575NA_3	Non anodized (raw)	3000 mm

TECHNICAL DRAWING

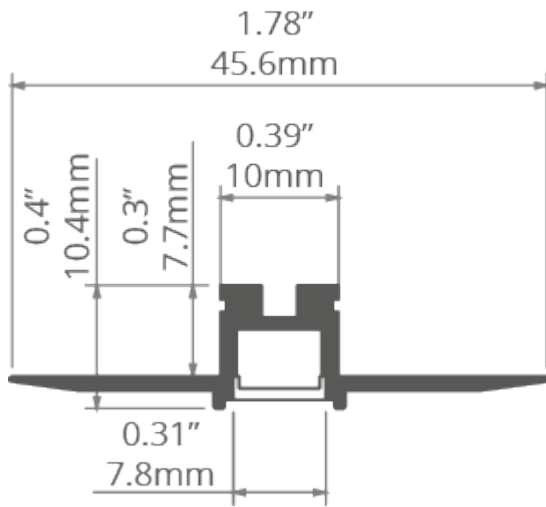

RELATED PRODUCTS

COVERS

FROSTED COVERS

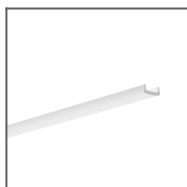

PIKO frosted Cover
Ref: 17034

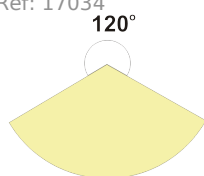

END CAPS

REGULAR END CAPS



PIKO-ZM grey End cap
Ref: 24307

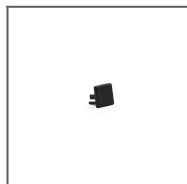

PIKO-ZM black End cap
Ref: 24384

REGULAR END CAPS WITH HOLE

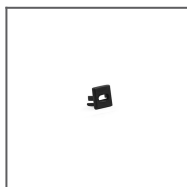

PIKO-ZM-OTW black End cap
Ref: 24400



PIKO-ZM-OTW grey End cap
Ref: 24359

ACCESSORIES

COMPONENTS FOR CONNECTING PROFILES



ZM-NA-90
Connector
Ref: 42723

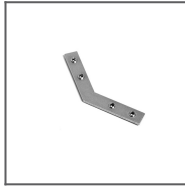

ZM-NA-135
Connector
Ref: 42725

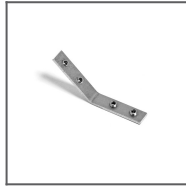

ZM-NA-PION-135
Connector
Ref: 42727

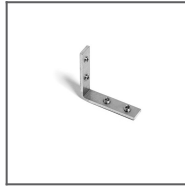

ZM-NA-PION-90
Connector
Ref: 42726

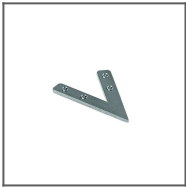

ZM-NA-45
Connector
Ref: 42339

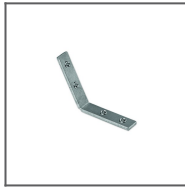

ZM-NA-PION-120
Connector
Ref: 42321

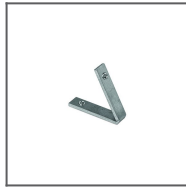

ZM-NA-PION-60
Connector
Ref: 42317



ZM-NA-PION-45
Connector
Ref: 42315



ZM-NA-60
Connector
Ref: 42305

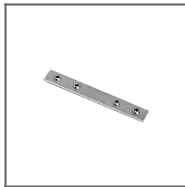

ZM-NA-180
Connector
Ref: 42724

ADDITIONAL ITEMS

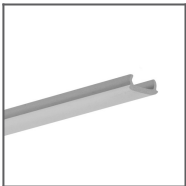

TECH-10
protective insert
Ref: 17126

MARKETING MATERIALS



Display
P230-90175M
Ref: 90175M



Foam 70424
Ref: 70424

LED TAPES

RGB / RGB-W

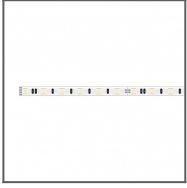

LED strip K-1560-
RGB-24V
Ref: K-1560-
RGB-24V