

PRODUCT DESCRIPTION

- Wall-to-wall mounting possible
- Glare rating UGR <19 possible
- Two lighting directions
- Space for power supply and electronic components
- Easy maintenance

FINISH :

Silver anodized RAL

*Custom colors available upon request

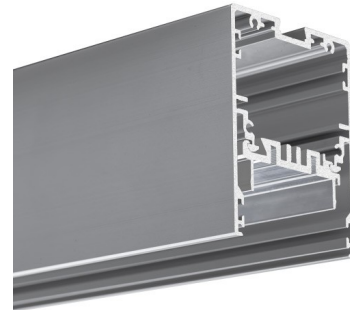

Fill empty fields

Product nr.

Fixture type

Company

Job name

Date

TECHNICAL SPECIFICATION

Application

- main and decorative lighting.

Mounting

- suspended, using dedicated accessories,
- can be easily connected into runs,
- the cover is cut to the length of the lighting fixture.

Additional information

- the MOD-50 lighting fixture can be anodized or painted. The MOD-50 lighting fixture can generate a strong downward beam (two LED strips 10 mm wide or a single firm LED module up to 24 mm wide) and an upward backlight beam (one 10 mm LED strip)
- the MOD-50 lighting fixture is designed so that its "core" (extrusion with LED strips, power supply, wires) can be fully prepared in advance (in factory conditions). At the destination of mounting, the ready "core" of MOD-50 can be snapped into the previously mounted housing frame and connected to power
- for each 1m of the lighting fixture, two locking bolts must be used. With lighting fixtures shorter than 1 m, at least 2 bolts must be used

span {font-weight:600;}

The MOD-50 lighting fixture is compatible with the following covers:

- JUN-50 prismatic, material: PMMA, length: 1.5 m, UV resistant , the possibility of obtaining a glare factor UGR ≤ 19

- POL-50 frosted, material: PC, lengths: 1 m, 2m, 3 m, UV resistant

AVAILABLE LENGTHS

| Ref. nr. | surface finish | available lengths |
|----------------|-----------------|-------------------|
| 18047ANODA_1 | Silver anodized | 1000 mm |
| 18047ANODA_2 | Silver anodized | 2000 mm |
| 18047ANODA_3 | Silver anodized | 3000 mm |
| 18047K7_1 | Black RAL | 1000 mm |
| 18047K7_2 | Black RAL | 2000 mm |
| 18047K7_3 | Black RAL | 3000 mm |
| 18047L9010OD_2 | White RAL | 2000 mm |

TECHNICAL DRAWING

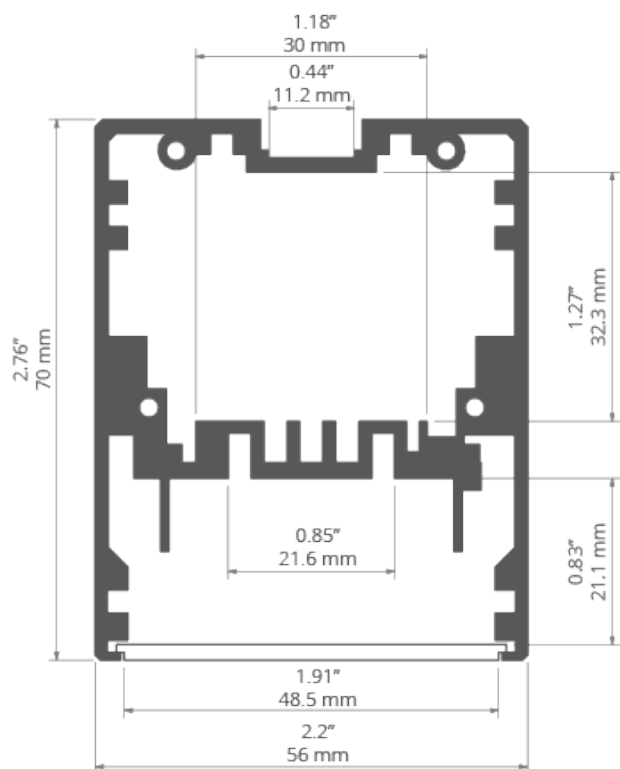

RELATED PRODUCTS

COVERS

CLEAR COVERS

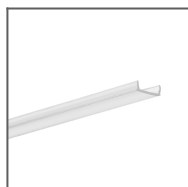

KA clear Cover
Ref: 17036

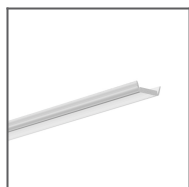

HS clear Cover
Ref: 1370

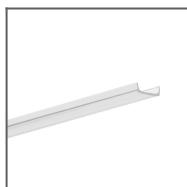

KA-COM clear
Cover
Ref: 17122

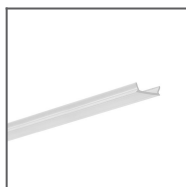

KA-PRO clear
Cover
Ref: 17065

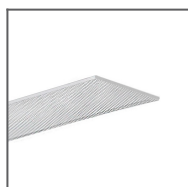

JUN-50 prismatic
Cover
Ref: 17056_1.5

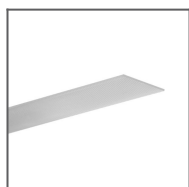

PRS-50 prismatic
Cover
Ref: 17169

FROSTED COVERS

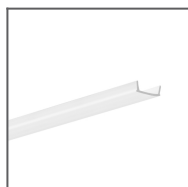

KA frosted Cover
Ref: 17035

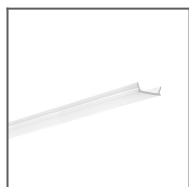

KA-PRO frosted
Cover
Ref: 17064

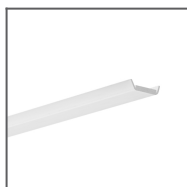

HS frosted Cover
Ref: 1369

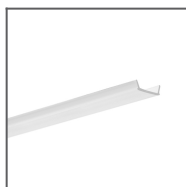

KA-COM frosted
Cover
Ref: 17121

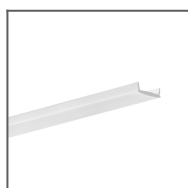

LIGER frosted
Cover
Ref: 17037

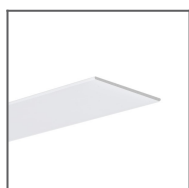

POL-50 frosted
Cover
Ref: 17058

END CAPS

REGULAR END CAPS



MOD-50 grey End cap
Ref: 24329



MOD-50 black End cap
Ref: 24405



MOD-50 white End cap
Ref: 24406

ACCESSORIES

FASTENERS & MOUNTING ACCESSORIES



M4-12 Fastener
Ref: 42246

COMPONENTS FOR CONNECTING PROFILES

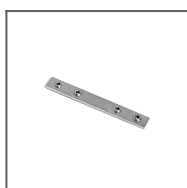

ZM-180 Connector
Ref: 42717

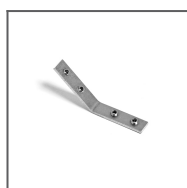

ZM-PION-135 Connector
Ref: 42719

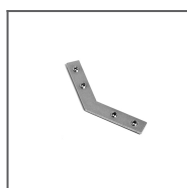

ZM-135 Connector
Ref: 42720

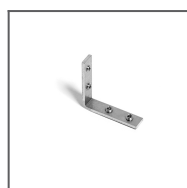

ZM-PION-90 Connector
Ref: 42718

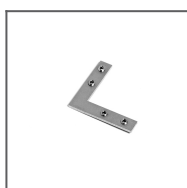

ZM-90 Connector
Ref: 42716

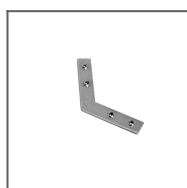

ZM-120 Connector
Ref: 42728

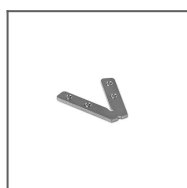

ZM-45-G Connector
Ref: 42338

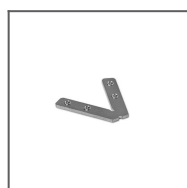

ZM-60-G Connector
Ref: 42304

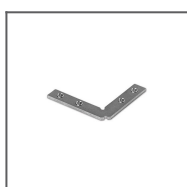

ZM-90-G Connector
Ref: 42306

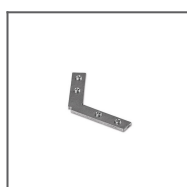

ZM-120-G Connector
Ref: 42308

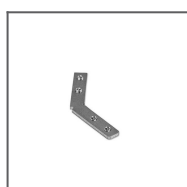

ZM-135-G Connector
Ref: 42310



ZM-PION-45 Connector
Ref: 42314

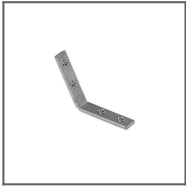

ZM-PION-120
Connector
Ref: 42320

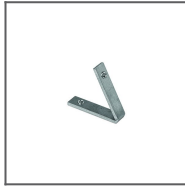

ZM-PION-60
Connector
Ref: 42316

MOUNTING SETS



RG-1 Fastener set
black
Ref: 42647L9005

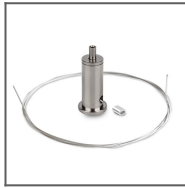

RG-1 Fastener set
silver
Ref: 42647NI



RG-1 Fastener set
white
Ref: 42647L9010



RG-1 Fastener set
silver satin
Ref: 42647GSS

SEALING COMPONENTS



M8 x 1 Gland
Ref: 42265

ADDITIONAL ITEMS



REFLEX 16-60
Reflector
Ref: 17003



Screw 2.9X6.5
DIN7981F
Ref: 70283

LED TAPES

WHITE

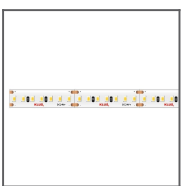

LED strip K-0530-
HD-24V 5.3W/m
Ref: K-0530-
HD-24V

HIGH EFFICACY



LED strip K-HE-0480-HD-24V
Ref: K-HE-0480-HD-24V



LED strip K-HE-0960-HD-24V
Ref: K-HE-0960-HD-24V



LED strip K-HE-1440-HD-24V
Ref: K-HE-1440-HD-24V



LED strip K-HE-1920-HD-24V
Ref: K-HE-1920-HD-24V

MARKETING MATERIALS



Foam 70343
Ref: 70343



Display P230-90174M
Ref: 90174M