

## PRODUCT DESCRIPTION

- Illumination of the niche and cove edge
- Easy maintenance
- Effect of a thin edge of the suspended ceiling
- Two lighting options

### FINISH :

Non anodized (raw) 

\*Custom colors available upon request



Fill empty fields

Product nr.

Fixture type

Company

Job name

Date

## TECHNICAL SPECIFICATION

### Application

- decorative lighting recessed in architectural niches.

### Mounting

- to the surface, using a dedicated mounting track and properly selected screws,
- can be easily connected into runs,
- the cover is cut to the length of the lighting fixture.

### Additional information

- can be mounted horizontally or vertically
- the light source is placed in the easily disassembled ONISA lighting fixture
- space for LED strip: 11.2 mm

## AVAILABLE LENGTHS

Ref. nr.	surface finish	available lengths
18029NA_1	Non anodized (raw)	1000 mm
18029NA_2	Non anodized (raw)	2000 mm
18029NA_3	Non anodized (raw)	3000 mm

**TECHNICAL DRAWING**

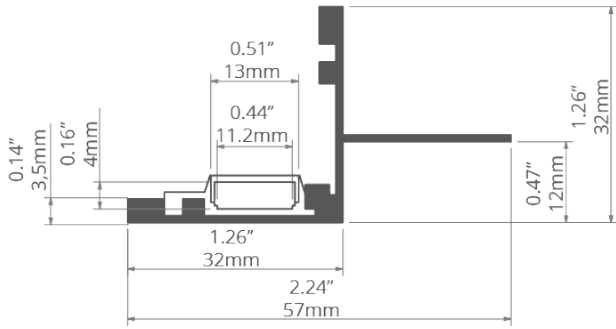

**RELATED PRODUCTS**

**COVERS**

**CLEAR COVERS**



KA clear Cover  
Ref: 17036

**110°**

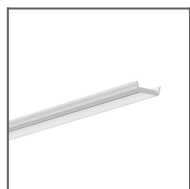

HS clear Cover  
Ref: 1370

**110°**

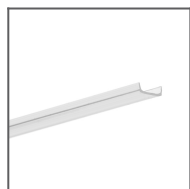

KA-COM clear Cover  
Ref: 17122

**100°**

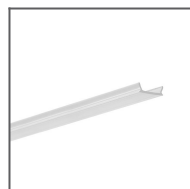

KA-PRO clear Cover  
Ref: 17065

**100°**



**FROSTED COVERS**



KA frosted Cover  
Ref: 17035

**110°**

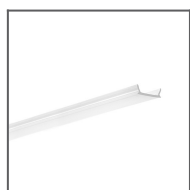
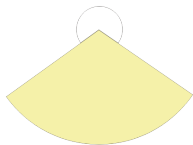

KA-PRO frosted Cover  
Ref: 17064

**110°**



HS frosted Cover  
Ref: 1369

**110°**

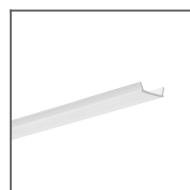

KA-COM frosted Cover  
Ref: 17121

**110°**

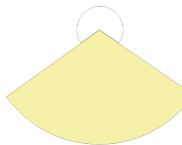

LIGER frosted Cover  
Ref: 17037

**120°**

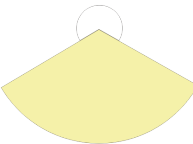

**END CAPS**

**REGULAR END CAPS**



ONISA grey End cap  
Ref: 24100

## ACCESSORIES

### COMPONENTS FOR CONNECTING PROFILES

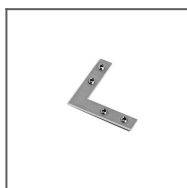

ZM-NA-90  
Connector  
Ref: 42723

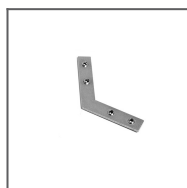

ZM-NA-120  
Connector  
Ref: 42729

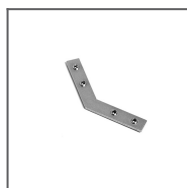

ZM-NA-135  
Connector  
Ref: 42725

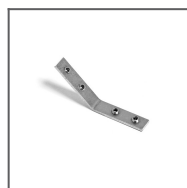

ZM-NA-PION-135  
Connector  
Ref: 42727

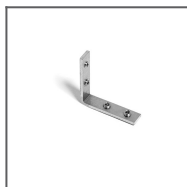

ZM-NA-PION-90  
Connector  
Ref: 42726

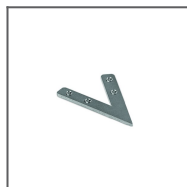

ZM-NA-45  
Connector  
Ref: 42339



ZM-NA-PION-120  
Connector  
Ref: 42321



ZM-NA-PION-60  
Connector  
Ref: 42317



ZM-NA-PION-45  
Connector  
Ref: 42315

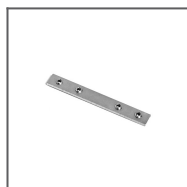

ZM-NA-180  
Connector  
Ref: 42724

### SEALING COMPONENTS



6 x 1.2 Gland  
Ref: 00802

### LED TAPES

WHITE

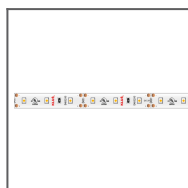

LED strip K-1210-12V  
Ref: K-1210-12V

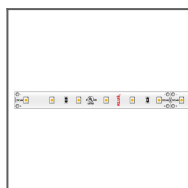

LED strip K-1210-24V  
Ref: K-1210-24V

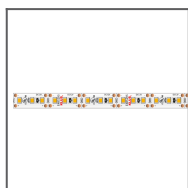

LED strip K-1220-12V  
Ref: K-1220-12V

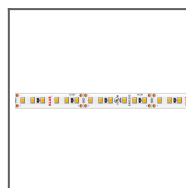

LED strip K-1220-24V  
Ref: K-1220-24V

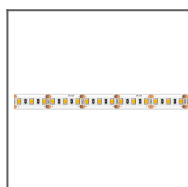

LED strip K-1275-12V  
Ref: K-1275-12V



LED strip K-1275-24V  
Ref: K-1275-24V

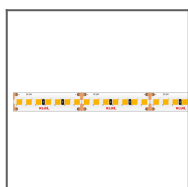

LED strip K-1820-HD-24V  
Ref: K-1820-HD-24V



LED strip K-1910-HD-24V  
Ref: K-1910-HD-24V

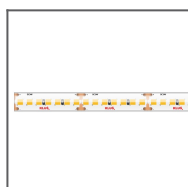

LED strip WP-K-1640-HD-IP65-24V  
Ref: WP-K-1640-HD-IP65-24V



LED strip WP-K-1210-12V  
Ref: WP-K-1210-12V



LED strip WP-K-1210-24V  
Ref: WP-K-1210-24V



Taśma LED WP-K-1220-12V  
Ref: WP-K-1220-12V



LED strip WP-K-1220-24V  
Ref: WP-K-1220-24V

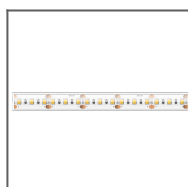

LED strip WP-K-1275-12V  
Ref: WP-K-1275-12V

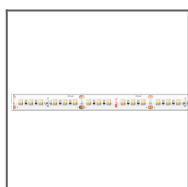

LED strip WP-K-1275-24V  
Ref: WP-K-1275-24V

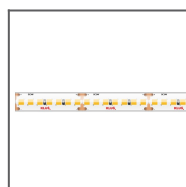

Taśma LED WP-K-1910-HD-IP65-24V  
Ref: WP-K-1910-HD-IP65-24V

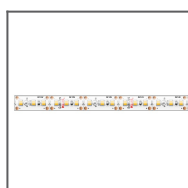

LED strip WP-K-1220-IP65-12V  
Ref: WP-K-1220-IP65-12V

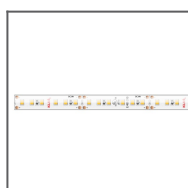

LED strip WP-K-1220-IP65-24V  
Ref: WP-K-1220-IP65-24V

LONG RUN



LED strip K-LR-1000-24V  
Ref: K-LR-1000-24V

HIGH EFFICACY



LED strip K-HE-0480-HD-24V  
Ref: K-HE-0480-HD-24V



LED strip K-HE-0960-HD-24V  
Ref: K-HE-0960-HD-24V

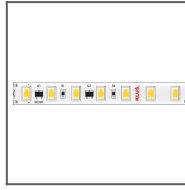

LED strip K-HE-1440-HD-24V  
Ref: K-HE-1440-HD-24V

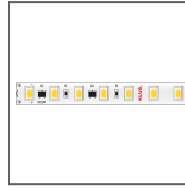

LED strip K-HE-1920-HD-24V  
Ref: K-HE-1920-HD-24V

RGB / RGB-W

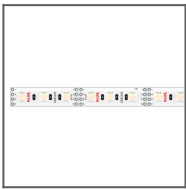

LED strip K-1275-RGB-12V  
Ref: K-1275-RGB-12V

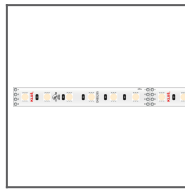

LED strip K-1275-RGB-24V  
Ref: K-1275-RGB-24V

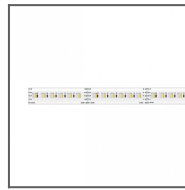

LED strip K-1530-RGB+W-24V  
Ref: K-1530-RGB+W-24V

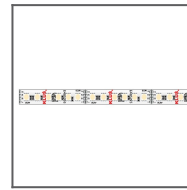

LED strip K-1920-120-RGB-24V  
19.2W/m  
Ref: K-1920-120-RGB-24V

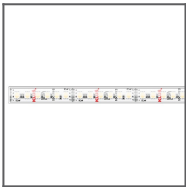

LED strip WP-K-1920-120-RGB-24V  
Ref: WP-K-1920-120-RGB-24V

TUNABLE WHITE / DIM TO WARM

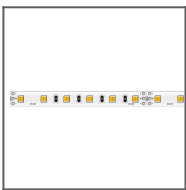

LED strip K-27/65-1920-24V  
Ref: K-27/65-1920-24V

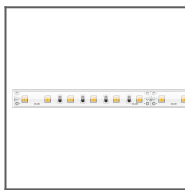

LED strip WP-K-27/65-1920-24V  
Ref: WP-K-27/65-1920-24V

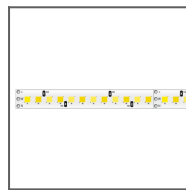

LED strip K-22/50-1728-24V  
Ref: K-22/50-1728-24V

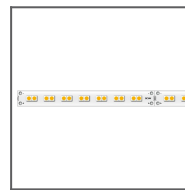

LED strip K-30/18-1770-24V  
Ref: K-30/18-1770-24V

MARKETING MATERIALS



Presentation set 5  
Ref: 90124