

## PRODUCT DESCRIPTION

- Longitudinal suspension on wires
- Mounting to the lighting fixture from the light source side
- Creating an installation from several lighting fixtures one under the other
- Possibility to conduct two poles of current

Fill empty fields

Product nr.

Fixture type

Company

Job name

Date



## TECHNICAL SPECIFICATION

### Application

- for suspending LED lighting fixtures

### Mounting

- to the lighting fixture, using a cover bracket
- to wires, using the pressure screws

### Additional information

- spare power connector included
- ATTENTION! in the case of installation in a profile without hooks at the cover bracket (e.g. GIZA-DUO-LL), remove the plastic holder in the lower part of the fastener

## TECHNICAL DRAWING

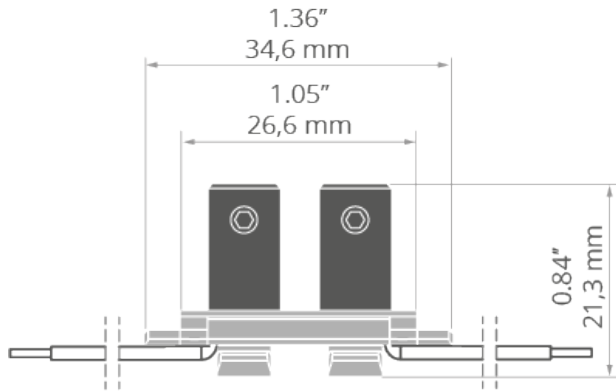

RELATED PROFILES

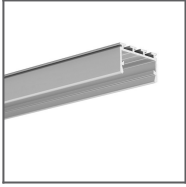

GIZA-LL profile  
Ref: C0758

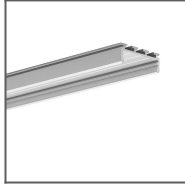

GIZA Profile  
Ref: B5556

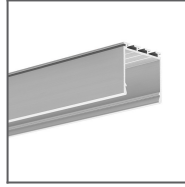

LIPOD Profile  
Ref: B5554

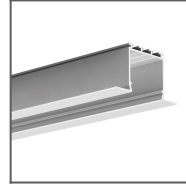

LARKO Profile  
Ref: B5552



GIZA-DUO-LL  
Profile  
Ref: C2162

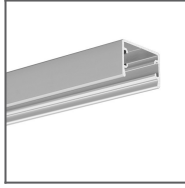

GLAZA-LL Profile  
Ref: C2627

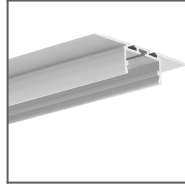

GIZA-LL-T Profile  
Ref: C2479

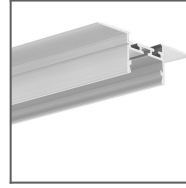

GIZA-LL-UST  
Profile  
Ref: C2724

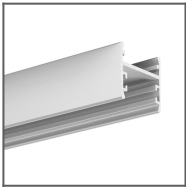

GLAZA-DUO  
Profile  
Ref: C3059