

PRODUCT DESCRIPTION

- Longitudinal suspension on wires
- Mounting to the lighting fixture from the light source side
- Creating an installation from several lighting fixtures one under the other
- Possibility to conduct two poles of current

Fill empty fields

Product nr.

Fixture type

Company

Job name

Date



TECHNICAL SPECIFICATION

Application

- for suspending LED lighting fixtures

Mounting

- to the lighting fixture, using a cover bracket
- to wires, using the pressure screws

Additional information

- spare power connector included
- ATTENTION! in the case of installation in a profile without hooks at the cover bracket (e.g. GIZA-DUO-LL), remove the plastic holder in the lower part of the fastener

TECHNICAL DRAWING

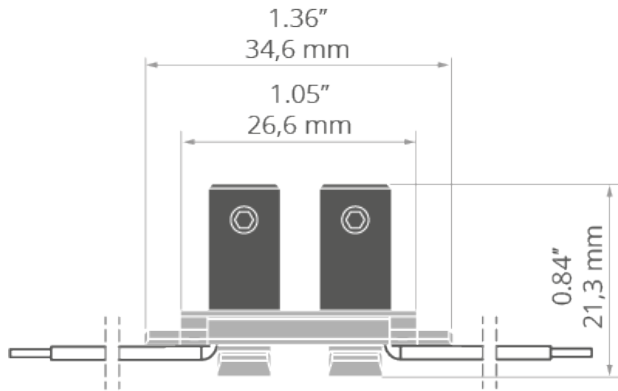

RELATED PROFILES

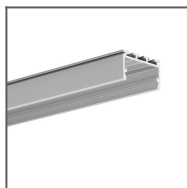

GIZA-LL profile
Ref: C0758

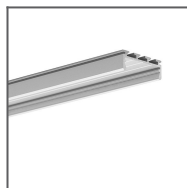

GIZA Profile
Ref: B5556

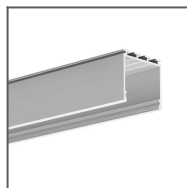

LIPOD Profile
Ref: B5554

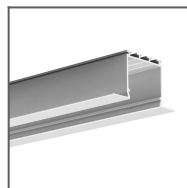

LARKO Profile
Ref: B5552



GIZA-DUO-LL
Profile
Ref: C2162

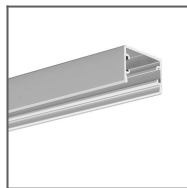

GLAZA-LL Profile
Ref: C2627

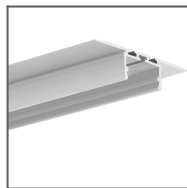

GIZA-LL-T Profile
Ref: C2479

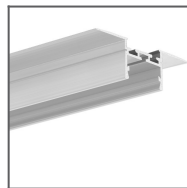

GIZA-LL-UST
Profile
Ref: C2724

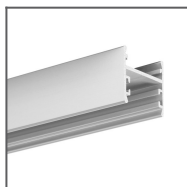

GLAZA-DUO
Profile
Ref: C3059