

PRODUCT DESCRIPTION

- Wide range of accessories
- Good heat dissipation
- Small bending radius

FINISH :

Non anodized (raw) Silver anodized Black anodized RAL  

*Custom colors available upon request

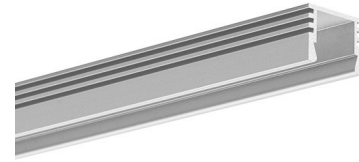

Fill empty fields

Product nr.

Fixture type

Company

Job name

Date

TECHNICAL SPECIFICATION

Application

- main, furniture and functional lighting.

Mounting

- to the surface, suspended or recessed, using dedicated accessories, properly selected screws, with double-sided adhesive tape or mounting adhesive,
- easy assembly and disassembly by snapping in and out.

Additional information

- possibility of making a linear fixture with IP65 protection, which means the fixture is dustproof and waterproof in contact with water jets
- possibility of making a linear fixture with IP67 protection, which means the fixture is dustproof and waterproof
- can be equipped with transparent and frosted covers, aluminum-colored plastic, metalized and conductive end caps
- space for LED strip: 11.2 mm

Profile bending with covers: HS, LIGER, KA. Suitable for bending in the plane adjacent to the LED strip.

Minimum internal radius	Minimum external radius
150 mm	250 mm

- minimum radius - bending radius which when exceeded causes destruction (deformation, bending or lack of compatibility with other accessories, e.g. covers, end caps, etc.) of the profile
- internal radius - refers to the profile bent so that the cover is facing the inside of the arch
- external radius - refers to the profile bent so that the cover is facing the outside of the arch
- irregular curves are possible after consultation and individual quotation
- when bending anodized profiles, one should be aware of cracking of the anode coating (which may be more or less visible depending on the radius)

AVAILABLE LENGTHS

Ref. nr.	surface finish	available lengths
B1718NA_1	Non anodized (raw)	1000 mm
B1718NA_2	Non anodized (raw)	2000 mm
B1718NA_3	Non anodized (raw)	3000 mm
B1718L9010NS_1	White RAL	1000 mm
B1718L9010NS_2	White RAL	2000 mm
B1718L9010OD_2	White RAL	2000 mm
B1718L9005NS_1	Black RAL	1000 mm
B1718L9005NS_2	Black RAL	2000 mm
B1718K7_1	Black anodized	1000 mm
B1718K7_2	Black anodized	2000 mm
B1718K7_3	Black anodized	3000 mm
B1718ANODA_1	Silver anodized	1000 mm
B1718ANODA_2	Silver anodized	2000 mm
B1718ANODA_3	Silver anodized	3000 mm

TECHNICAL DRAWING

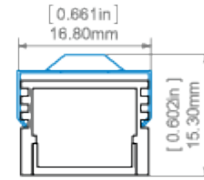
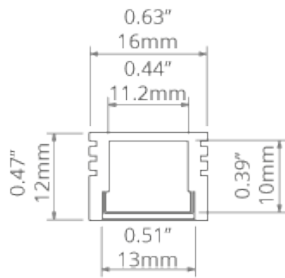

PDS-4-ALU profile and PDS-STN mounting bracket
profil PDS-4-ALU z mocownikiem PDS-STN

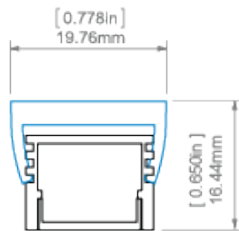

PDS-4-ALU profile and PL-PDM mounting bracket
profil PDS-4-ALU z mocownikiem PL-PDM

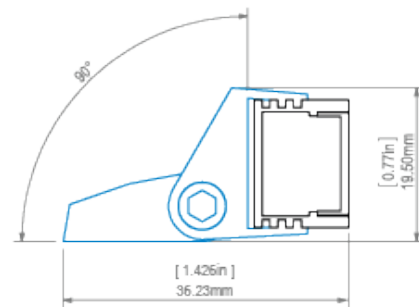

PDS-4-ALU profile and REG-PD-UV mounting bracket
profil PDS-4-ALU z mocownikiem REG-PD-UV

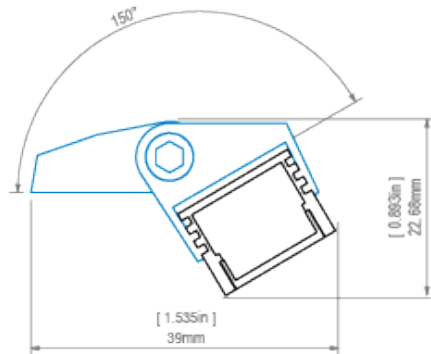

PDS-4-ALU profile and REG-PD-UV mounting bracket
profil PDS-4-ALU z mocownikiem REG-PD-UV

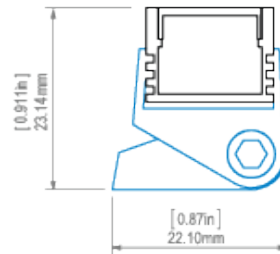

PDS-4-ALU profile and REG-PD-UV mounting bracket
profil PDS-4-ALU z mocownikiem REG-PD-UV

RELATED PRODUCTS

COVERS

BLACK COVERS

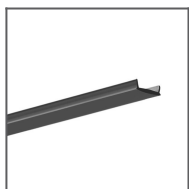

LIGER black Cover

Ref: 17040

90°



CLEAR COVERS

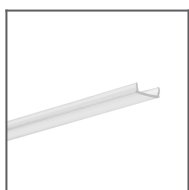

KA clear Cover

Ref: 17036

60°

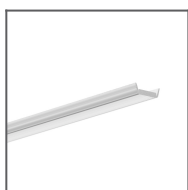

HS clear Cover

Ref: 1370

50°

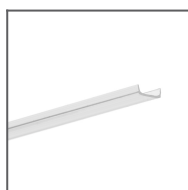

KA-COM clear Cover

Ref: 17122

70°

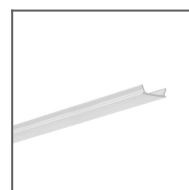

KA-PRO clear Cover

Ref: 17065

50°



FROSTED COVERS

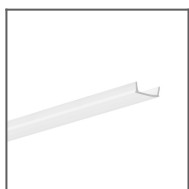

KA frosted Cover

Ref: 17035

90°

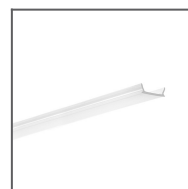
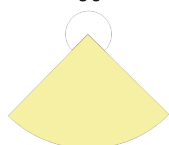

KA-PRO frosted Cover

Ref: 17064

100°

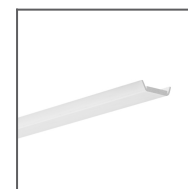
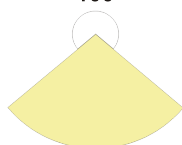

HS frosted Cover

Ref: 1369

100°

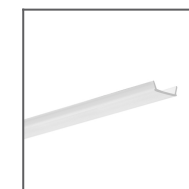

KA-COM frosted Cover

Ref: 17121

100°



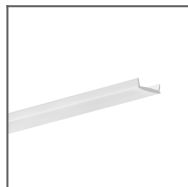

LIGER frosted Cover
Ref: 17037

120°



END CAPS

REGULAR END CAPS

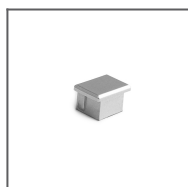

PDS-4-ALU metalized End cap
Ref: 24061

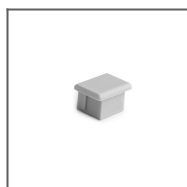

PDS-4-ALU grey End cap
Ref: 1056

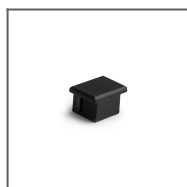

PDS-4-ALU black End cap
Ref: 24066

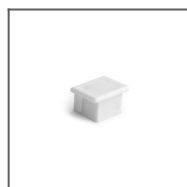

PDS-4-ALU End cap ral9010
Ref: 20002

REGULAR END CAPS WITH HOLE

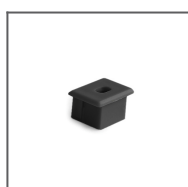

PDS-4-ALU-OTW black End cap
Ref: 24081

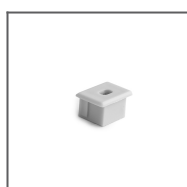

PDS-4-ALU-OTW grey End cap
Ref: 1057

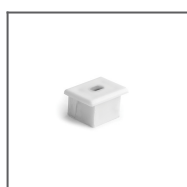

PDS-4-OTW white End cap
Ref: 21002

MICRO SWITCH END CAPS



PDS-4-MW white End cap
Ref: 22002

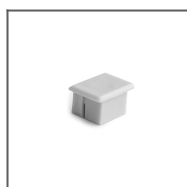

PDS-4-ALU-MW grey End cap
Ref: 00026

MICRO SWITCH WITH HOLE



PDS-4-ALU-OTW-MW
grey End cap
Ref: 00027

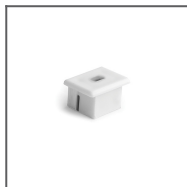

PDS-4-OTW-MW
white End cap
Ref: 23002



PDS4-ALU-OTW-MW
black End cap
Ref: 24162

ELECTRICITY CONDUCTIVE END CAPS



PDS-4-ALU grey
electricity
conductive End
cap
Ref: 1407

ACCESSORIES

FASTENERS & MOUNTING ACCESSORIES



REG-PD-UV
Mounting bracket
Ref: 24270

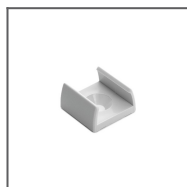

PL-PDM Mounting
bracket
Ref: 24041

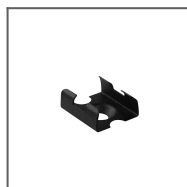

PDS Mounting
bracket
Ref: 24189

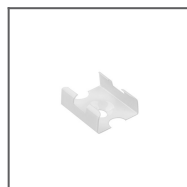

PDS Mounting
bracket
Ref: 24223

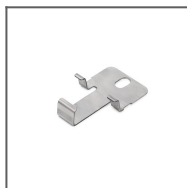

PDS-STN-ALFA
Mounting bracket
Ref: 24426

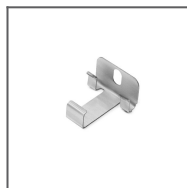

PDS-STN-90D
Mounting bracket
Ref: 24367



PDS-STN-90G
Mounting bracket
Ref: 24370



PDS-STN
Mounting bracket
Ref: 24190

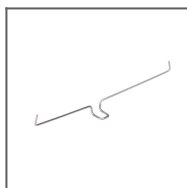

PDS Spring
Ref: 00800



ZZ Head
Ref: 42218



BZP-ZO Head
Ref: 42214



BZP-ZZ Head
Ref: 42215



BZP Head
Ref: 42213



ST Head
Ref: 42216



ZO Head
Ref: 42217



PUSZ-PRET-MR
Fastener black
Ref: 42281L9005



PUSZ-LIN-MR
Fastener black
Ref: 42278L9005



PUSZ-LIN-MR
Fastener silver
Ref: 42278



PUSZ-LIN-MR
Fastener white
Ref: 42278L9010



PUSZ-PRET-MR
Fastener white
Ref: 42281L9010



PUSZ-PRET-MR
Fastener silver
Ref: 42281



FI-8-LIN-MR
Fastener white
Ref: 42287L9010



PUSZ-PRET-MR
Fastener
Ref: 42252



PUSZ-LIN-MR
Fastener
Ref: 42258



FI-8-LIN-MR
Fastener black
Ref: 42287L9005



FI-8-LIN-MR
Fastener silver
Ref: 42287



DP-ZZ Fastener
Ref: 00651



DP-MOC-ZO
Fastener
Ref: 00646



DP-ZO Fastener
Ref: 00649

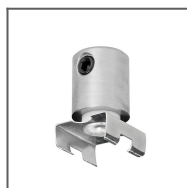

DP-MOC Fastener
Ref: 00645

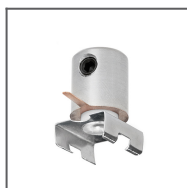

DP-MOC-ZZ
Fastener
Ref: 00647



DP Fastener
Ref: 00644

COMPONENTS FOR CONNECTING PROFILES

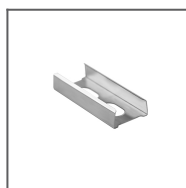

PD-MICRO
Connector
Ref: 42150

MOUNTING SETS



W1 Fastener set
Ref: 42602



W2 Fastener set
Ref: 42603



M3 Fastener set
Ref: 42303



M4 Fastener set
Ref: 42301



M5 Fastener set
Ref: 42302



W6 Fastener set
Ref: 42604



W7 Fastener set
Ref: 42605



W9 Fastener set
Ref: 42607



W10 Fastener set
Ref: 42608



M11 Fastener set
Ref: 42609



M12 Fastener set
Ref: 42610

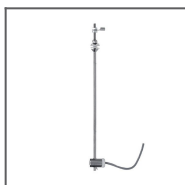

M13 Fastener set
Ref: 42611



M14 Fastener set
Ref: 42612



RG-1 Fastener set
black
Ref: 42647L9005



RG-1 Fastener set
silver
Ref: 42647NI

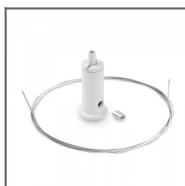

RG-1 Fastener set
white
Ref: 42647L9010



RG-1 Fastener set
silver satin
Ref: 42647G55

SEALING COMPONENTS



6 x 1.2 Gland
Ref: 00802



6.4 x 1.6 Gland
Ref: 00802L

LED TAPES

WHITE

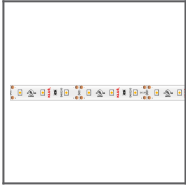

LED strip
K-1210-12V
Ref: K-1210-12V

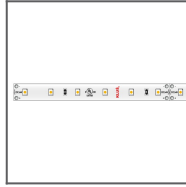

LED strip
K-1210-24V
Ref: K-1210-24V



LED strip K-1220-12V
Ref: K-1220-12V

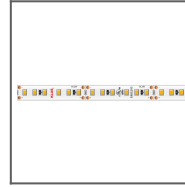

LED strip
K-1220-24V
Ref: K-1220-24V

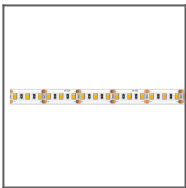

LED strip
K-1275-12V
Ref: K-1275-12V

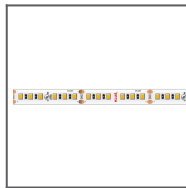

LED strip
K-1275-24V
Ref: K-1275-24V

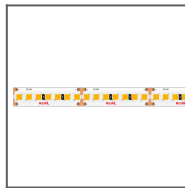

LED strip K-1820-
HD-24V
Ref: K-1820-HD-24V

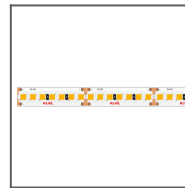

LED strip K-1910-
HD-24V
Ref: K-1910-HD-24V



LED strip WP-
K-1210-12V
Ref: WP-K-1210-12V

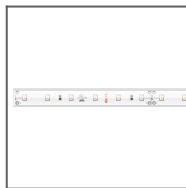

LED strip WP-
K-1210-24V
Ref: WP-
K-1210-24V

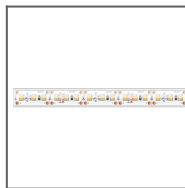

Taśma LED WP-
K-1220-12V
Ref: WP-K-1220-12V

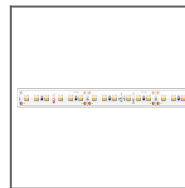

LED strip LED WP-
K-1220-24V
Ref: WP-K-1220-24V

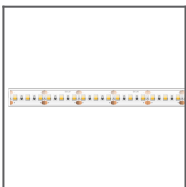

LED strip WP-
K-1275-12V
Ref: WP-K-1275-12V

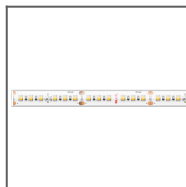

LED strip WP-
K-1275-24V
Ref: WP-
K-1275-24V

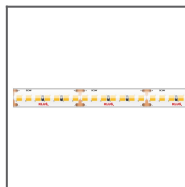

Taśma LED WP-K-1910-
HD-IP65-24V
Ref: WP-K-1910-HD-
IP65-24V

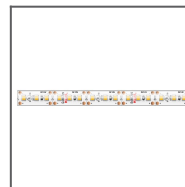

LED strip WP-
K-1220-IP65-12V
Ref: WP-K-1220-
IP65-12V



LED strip WP-
K-1220-IP65-24V
Ref: WP-K-1220-
IP65-24V

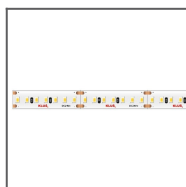

LED strip K-0530-
HD-24V 5.3W/m
Ref: K-0530-
HD-24V

LONG RUN

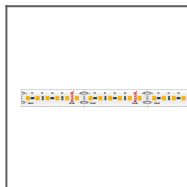

LED strip K-
LR-1000-24V
Ref: K-
LR-1000-24V

HIGH EFFICACY

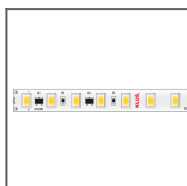

LED strip K-
HE-0480-HD-24V
Ref: K-HE-0480-
HD-24V

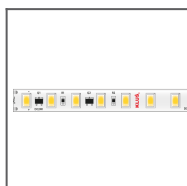

LED strip K-
HE-0960-HD-24V
Ref: K-HE-0960-
HD-24V

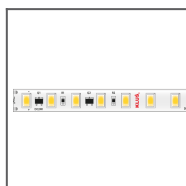

LED strip K-
HE-1440-HD-24V
Ref: K-HE-1440-
HD-24V

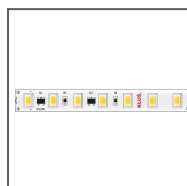

LED strip K-
HE-1920-HD-24V
Ref: K-HE-1920-
HD-24V

RGB / RGB-W

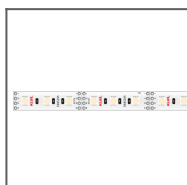

LED strip K-1275-
RGB-12V
Ref: K-1275-RGB-12V

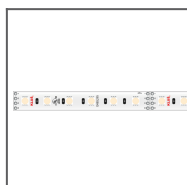

LED strip K-1275-
RGB-24V
Ref: K-1275-
RGB-24V

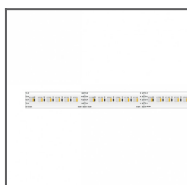

LED strip K-1530-
RGB+W-24V
Ref: K-1530-
RGB+W-24V

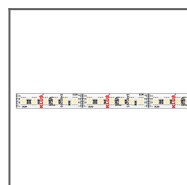

LED strip
K-1920-120-RGB-24V
19.2W/m
Ref: K-1920-120-
RGB-24V

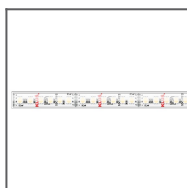

LED strip WP-
K-1920-120-RGB-24V
Ref: WP-K-1920-120-
RGB-24V

TUNABLE WHITE / DIM TO WARM

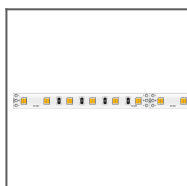

LED strip
K-27/65-1920-24V
Ref:
K-27/65-1920-24V



LED strip WP-
K-27/65-1920-24V
Ref: WP-
K-27/65-1920-24V

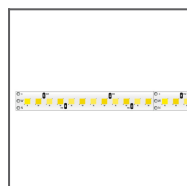

LED strip
K-22/50-1728-24V
Ref:
K-22/50-1728-24V

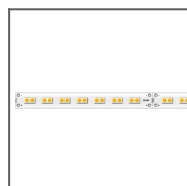

LED strip
K-30/18-1770-24V
Ref:
K-30/18-1770-24V

MARKETING MATERIALS



Display
P230-90120M
Ref: 90120M



Presentation set 1
Ref: 90051



Display
P230-90154M
Ref: 90154M