

PRODUCT DESCRIPTION

- Invisible groove edge
- Wide range of accessories
- Small bending radius

FINISH :

Silver anodized Black anodized

*Custom colors available upon request



Fill empty fields

Product nr.

Fixture type

Company

Job name

Date

TECHNICAL SPECIFICATION

Application

- furniture, main and decorative lighting.

Mounting

- recessed, using properly selected screws, mounting adhesive or double-sided adhesive tape.

Additional information

- possibility of making a linear fixture with IP67 protection, which means the fixture is dustproof and waterproof
- space for LED strip: 11.3 mm

Profile bending

Minimum internal radius	Minimum external radius
150 mm	150 mm

- minimum radius - bending radius which when exceeded causes destruction (deformation, bending or lack of compatibility with other accessories, e.g. covers, end caps, etc.) of the profile
- internal radius - refers to the profile bent so that the cover is facing the inside of the arch
- external radius - refers to the profile bent so that the cover is facing the outside of the arch
- irregular curves are possible after consultation and individual quotation
- when bending anodized profiles, one should be aware of cracking of the anode coating (which may be more or less visible depending on the radius)

AVAILABLE LENGTHS

Ref. nr.	surface finish	available lengths
B3776ANODA_1	Silver anodized	1000mm
B3776ANODA_2	Silver anodized	2000 mm
B3776ANODA_3	Silver anodized	3000 mm
B3776K7_1	Black anodized	1000 mm
B3776K7_2	Black anodized	2000 mm
B3776K7_3	Black anodized	3000 mm

TECHNICAL DRAWING

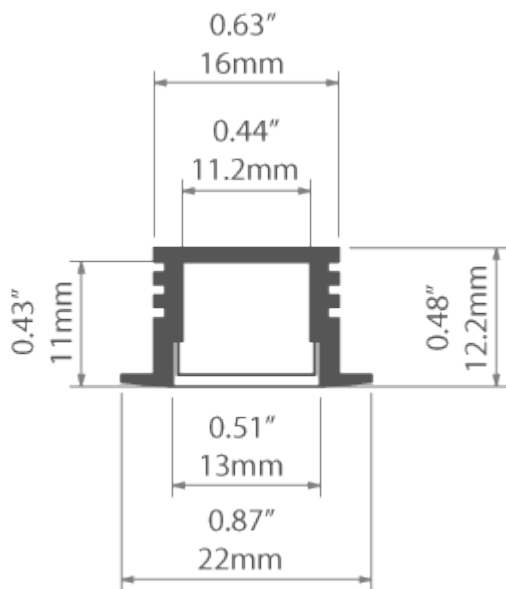

RELATED PRODUCTS

COVERS

BLACK COVERS

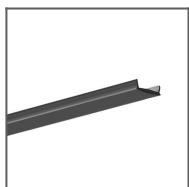

LIGER black Cover

Ref: 17040

90°

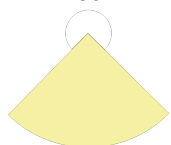

CLEAR COVERS

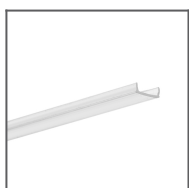

KA clear Cover

Ref: 17036

60°

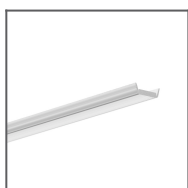

HS clear Cover

Ref: 1370

50°

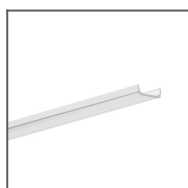

KA-COM clear Cover

Ref: 17122

70°

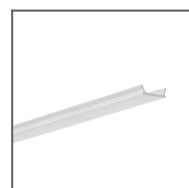

KA-PRO clear Cover

Ref: 17065

50°



FROSTED COVERS

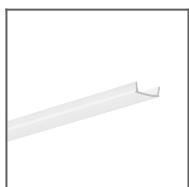

KA frosted Cover

Ref: 17035

90°

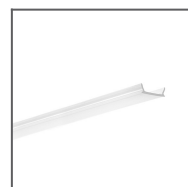
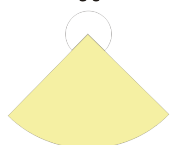

KA-PRO frosted Cover

Ref: 17064

100°

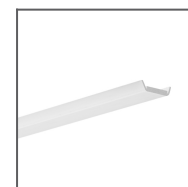

HS frosted Cover

Ref: 1369

100°

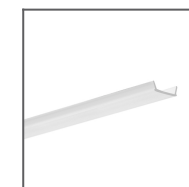

KA-COM frosted Cover

Ref: 17121

100°



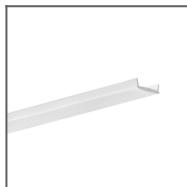

LIGER frosted Cover
Ref: 17037

120°



END CAPS

REGULAR END CAPS

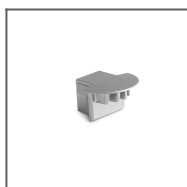

PDS-4-K
metalized End
cap
Ref: 24063

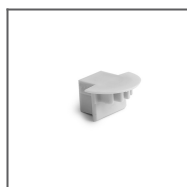

PDS-4-K grey End
cap
Ref: 1438



PDS-4-K black
End cap
Ref: 24067

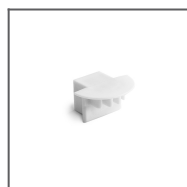

PDS-4-K End cap
ral9010
Ref: 20005

REGULAR END CAPS WITH HOLE



PDS-4-K-OTW
black End cap
Ref: 24082

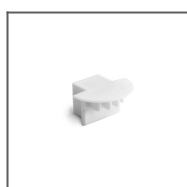

PDS-4-K-OTW
white End cap
Ref: 21005

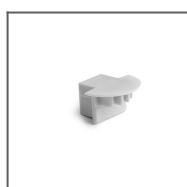

PDS-4-K-OTW
grey End cap
Ref: 1447

MICRO SWITCH END CAPS



PDS-4-K-MW
white End cap
Ref: 22005



PDS-4-K-MW grey
End cap
Ref: 00032

MICRO SWITCH WITH HOLE



PDS-4-K-OTW-MW
grey End cap
Ref: 00309



PDS-4-K-OTW-MW
white End cap
Ref: 23005

ACCESSORIES

SEALING COMPONENTS



6 x 1.2 Gland
Ref: 00802



6.4 x 1.6 Gland
Ref: 00802L

LED TAPES

WHITE

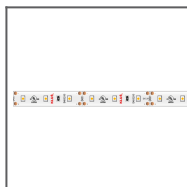

LED strip K-1210-12V
Ref: K-1210-12V

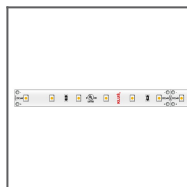

LED strip
K-1210-24V
Ref: K-1210-24V

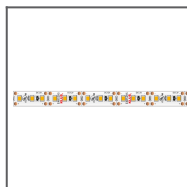

LED strip
K-1220-12V
Ref: K-1220-12V



LED strip K-1220-24V
Ref: K-1220-24V

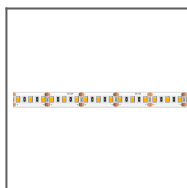

LED strip K-1275-12V
Ref: K-1275-12V



LED strip
K-1275-24V
Ref: K-1275-24V

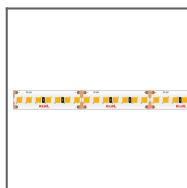

LED strip K-1820-
HD-24V
Ref: K-1820-
HD-24V



LED strip K-1910-
HD-24V
Ref: K-1910-HD-24V

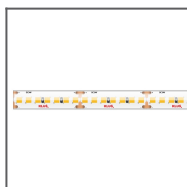

LED strip WP-K-1640-
HD-IP65-24V
Ref: WP-K-1640-HD-
IP65-24V



LED strip WP-
K-1210-12V
Ref: WP-K-1210-12V

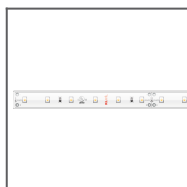

LED strip WP-
K-1210-24V
Ref: WP-
K-1210-24V



Taśma LED WP-
K-1220-12V
Ref: WP-K-1220-12V

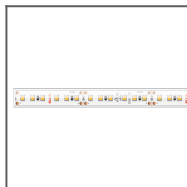

LED strip LED WP-K-1220-24V
Ref: WP-K-1220-24V

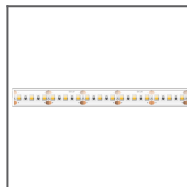

LED strip WP-K-1275-12V
Ref: WP-K-1275-12V

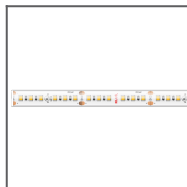

LED strip WP-K-1275-24V
Ref: WP-K-1275-24V



Taśma LED WP-K-1910-HD-IP65-24V
Ref: WP-K-1910-HD-IP65-24V



LED strip WP-K-1220-IP65-12V
Ref: WP-K-1220-IP65-12V

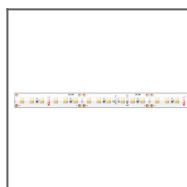

LED strip WP-K-1220-IP65-24V
Ref: WP-K-1220-IP65-24V

LONG RUN

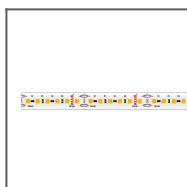

LED strip K-LR-1000-24V
Ref: K-LR-1000-24V

HIGH EFFICACY

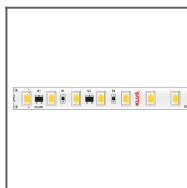

LED strip K-HE-0480-HD-24V
Ref: K-HE-0480-HD-24V

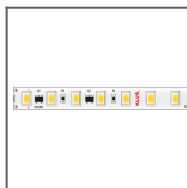

LED strip K-HE-0960-HD-24V
Ref: K-HE-0960-HD-24V

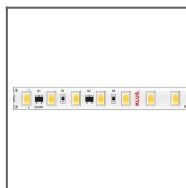

LED strip K-HE-1440-HD-24V
Ref: K-HE-1440-HD-24V

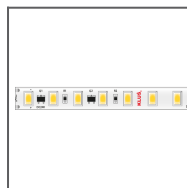

LED strip K-HE-1920-HD-24V
Ref: K-HE-1920-HD-24V

RGB / RGB-W

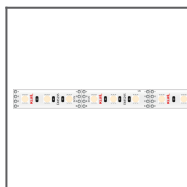

LED strip K-1275-RGB-12V
Ref: K-1275-RGB-12V

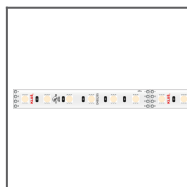

LED strip K-1275-RGB-24V
Ref: K-1275-RGB-24V

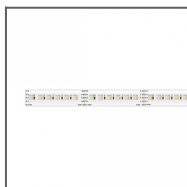

LED strip K-1530-RGB+W-24V
Ref: K-1530-RGB+W-24V

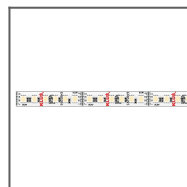

LED strip K-1920-120-RGB-24V
19.2W/m
Ref: K-1920-120-RGB-24V

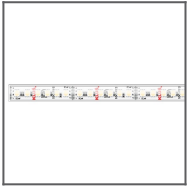

LED strip WP-
K-1920-120-RGB-24V
Ref: WP-K-1920-120-
RGB-24V

TUNABLE WHITE / DIM TO WARM

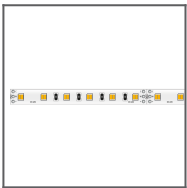

LED strip
K-27/65-1920-24V
Ref:
K-27/65-1920-24V

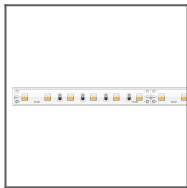

LED strip WP-
K-27/65-1920-24V
Ref: WP-
K-27/65-1920-24V

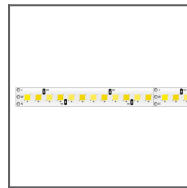

LED strip
K-22/50-1728-24V
Ref:
K-22/50-1728-24V

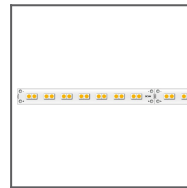

LED strip
K-30/18-1770-24V
Ref:
K-30/18-1770-24V

MARKETING MATERIALS



Presentation set 1
Ref: 90051