

PRODUCT DESCRIPTION

The information contained in the description applies to the PIKO-ZM system (a set of PIKO-ZM and TEPIKO profiles)

- Minimum width and height
- Easy maintenance
- Wide range of accessories
- Small bending radius

FINISH :

Silver anodized

Black anodized

*Custom colors available upon request



Fill empty fields

Product nr.

Fixture type

Company

Job name

Date

TECHNICAL SPECIFICATION

Application

- furniture and decorative lighting.

Mounting

- to the surface, suspended or recessed, using a dedicated mounting track, dedicated accessories, or mounting adhesive,
- can be easily connected into runs,
- the cover is cut to the length of the profile.

Additional information

- fast and reliable installation of sealed LED strips "5-KLIK" (LED strip in a special silicone sleeve ensuring increased tightness)
- Ideal for use in bathrooms and other rooms with high humidity
- recommendation:

Profile length	1 m	2 m	3 m
Number of TEKNIK latches	4	9	14

- the TEPIKO profile is sold with the "TEPIKO protective insert"
- space for LED strip: 7.2 mm

Profile bending

- the profile can be twisted along the axis

Minimum internal radius	Minimum external radius
220 mm	120 mm

- minimum radius- bending radius which when exceeded causes destruction (deformation, bending or lack of compatibility with other accessories, e.g. covers, end caps, etc.) of the profile
- internal radius- refers to the profile bent so that the cover is facing the inside of the arch
- external radius- refers to the profile bent so that the cover is facing the outside of the arch
- irregular curves are possible after consultation and individual quotation
- when bending anodized profiles, one should be aware of cracking of the anode coating (which may be more or less visible depending on the radius)

AVAILABLE LENGTHS

Ref. nr.	surface finish	available lengths
C1168ANODA_1	Silver anodized	1000 mm
C1168ANODA_2	Silver anodized	2000 mm
C1168ANODA_3	Silver anodized	3000 mm
C1168K7_1	Black anodized	1000 mm
C1168K7_2	Black anodized	2000 mm
C1168K7_3	Black anodized	3000 mm

TECHNICAL DRAWING

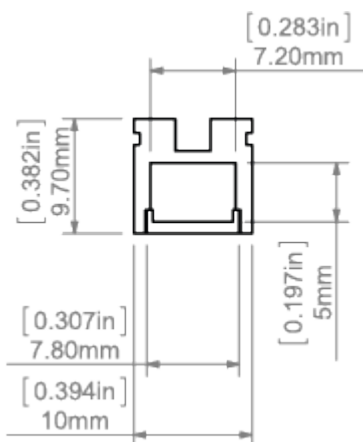

RELATED PROFILES



TEPIKO Profile
Ref: 18046

RELATED PRODUCTS

COVERS

FROSTED COVERS

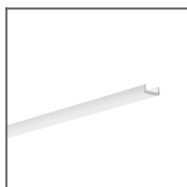

PIKO frosted Cover
Ref: 17034

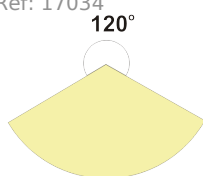

END CAPS

REGULAR END CAPS



PIKO-ZM grey End cap
Ref: 24307

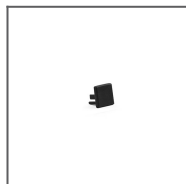

PIKO-ZM black End cap
Ref: 24384

REGULAR END CAPS WITH HOLE

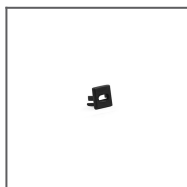

PIKO-ZM-OTW black End cap
Ref: 24400



PIKO-ZM-OTW grey End cap
Ref: 24359

ACCESSORIES

FASTENERS & MOUNTING ACCESSORIES



NEO-ZM-4
Mounting
brackets set
Ref: 42128



K-10 Mounting
bracket
Ref: 24340



NEO-ZM-3
Mounting
brackets set
Ref: 42127



K-10-WP Fastener
silver
Ref: 42671



K-10-WL Fastener
silver
Ref: 42672



K-10-PP Fastener
silver
Ref: 42670



FI-8-LIN-ZM
Fastener black
Ref: 42285L9005



FI-8-LIN-ZM
Fastener white
Ref: 42286L9010



FI-8-LIN-ZMZ
Fastener silver
Ref: 42286

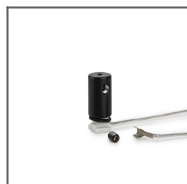

FI-8-LIN-ZMZ
Fastener black
Ref: 42286L9005



FI-10-ZM-W
Fastener
Ref: 42242



FI-10-ZM-P
Fastener
Ref: 42244



PUSZ-PRET-ZM
Fastener
Ref: 42250



FI-8-LIN-ZM
Fastener white
Ref: 42285L9010



FI-8-LIN-ZM
Fastener silver
Ref: 42285



PUSZ-LIN-ZM
Fastener
Ref: 42256

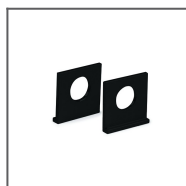

UCHO-ZM black
Hanger
Ref: 42525

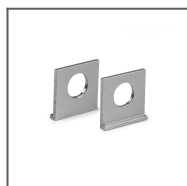

UCHO-ZM Hanger
Ref: 42512

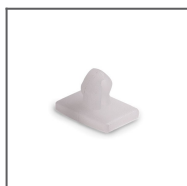

TEKNIK Latch
Ref: 24003

COMPONENTS FOR CONNECTING PROFILES

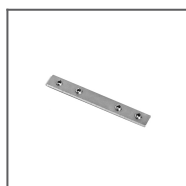

ZM-180
Connector
Ref: 42717



ZM-PION-45
Connector
Ref: 42314

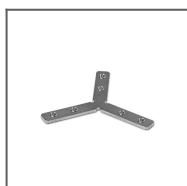

ZM-Y120-G
Connector
Ref: 42336

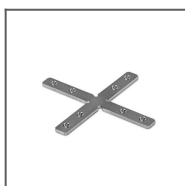

ZM-X90-G
Connector
Ref: 42334

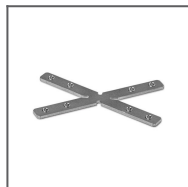

ZM-X60-G
Connector
Ref: 42332

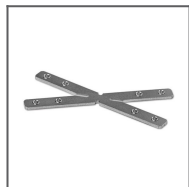

ZM-X45-G
Connector
Ref: 42330

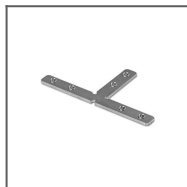

ZM-T90-G
Connector
Ref: 42328

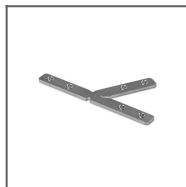

ZM-T60-G
Connector
Ref: 42326

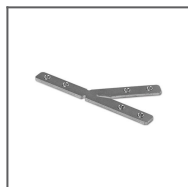

ZM-T45-G
Connector
Ref: 42324



ZM-PION-120
Connector
Ref: 42320

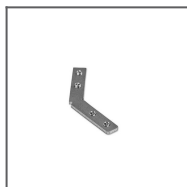

ZM-135-G
Connector
Ref: 42310

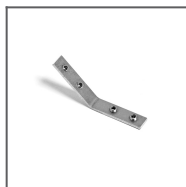

ZM-PION-135
Connector
Ref: 42719

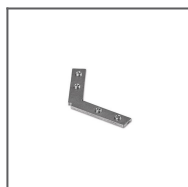

ZM-120-G
Connector
Ref: 42308

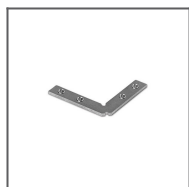

ZM-90-G
Connector
Ref: 42306

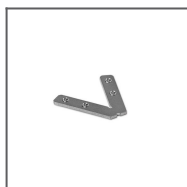

ZM-60-G
Connector
Ref: 42304

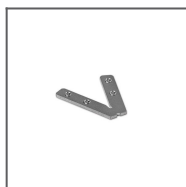

ZM-45-G
Connector
Ref: 42338

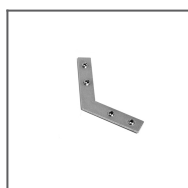

ZM-120
Connector
Ref: 42728

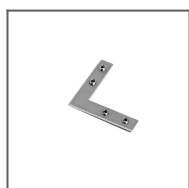

ZM-90 Connector
Ref: 42716

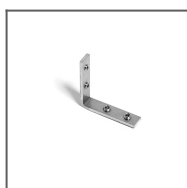

ZM-PION-90
Connector
Ref: 42718

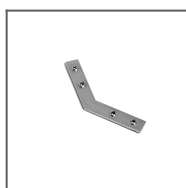

ZM-135
Connector
Ref: 42720

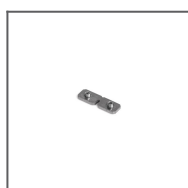

ZM-MINI-180
Connector
Ref: 44501

MOUNTING SETS



RD-1 Fastener set
black
Ref: 42658L9005



RG-1 Fastener set
black
Ref: 42647L9005



RG-1 Fastener set
silver
Ref: 42647NI



RD-1 Fastener set
silver
Ref: 42658NI



RD-1 Fastener set
white
Ref: 42658L9010



RD-1 Fastener set
silver satin
Ref: 42658GSS



RD-2 Fastener set
silver
Ref: 42653NI



RD-3 Fastener set
silver satin
Ref: 42659GSS



RD-4 Fastener set
silver
Ref: 42657NI



RG-1 Fastener set
white
Ref: 42647L9010



RD-2 Fastener set
white
Ref: 42653L9010



RD-2 Fastener set
silver satin
Ref: 42653GSS



RD-3 Fastener set
black
Ref: 42659L9005



RD-3 Fastener set
white
Ref: 42659L9010



RD-4 Fastener set
black
Ref: 42657L9005

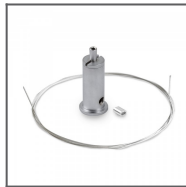

RG-1 Fastener set
silver satin
Ref: 42647GSS

SEALING COMPONENTS



6.4 x 3.0 Gland
Ref: 42264

LED TAPES



LED strip 5K-WP-
K-1091-24V
Ref: 5K-WP-
K-1091-24V

RGB / RGB-W

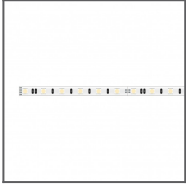

LED strip K-1560-
RGB-24V
Ref: K-1560-
RGB-24V

MARKETING MATERIALS



Foam 70341
Ref: 70341



Display
P230-90172M
Ref: 90172M