

PRODUCT DESCRIPTION

- Simplified design
- Wide range of accessories

FINISH :

Silver anodized

*Custom colors available upon request



Fill empty fields

Product nr.

Fixture type

Company

Job name

Date

TECHNICAL SPECIFICATION

Application

- main, functional, furniture and decorative lighting.

Mounting

- to the surface, suspended or recessed, using dedicated accessories, properly selected screws, double-sided adhesive tape or mounting adhesive,
- the cover is cut to the length of the profile,
- easy assembly and disassembly by snapping in and out.

Additional information

- to obtain a fully illuminated cover (without shadows at the end caps), it is recommended to use LED strips with a maximum width of 10 mm

AVAILABLE LENGTHS

Ref. nr.	surface finish	available lengths
C1919ANODA_1	Silver anodized	1000 mm
C1919ANODA_2	Silver anodized	2000 mm

TECHNICAL DRAWING

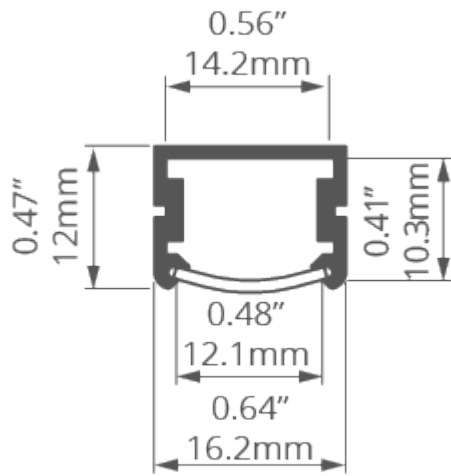

RELATED PRODUCTS

COVERS

FROSTED COVERS

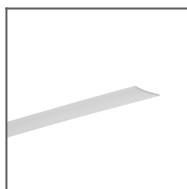

T frosted Cover
Ref: 17009

END CAPS

REGULAR END CAPS

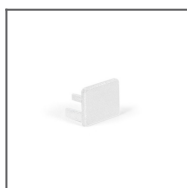

TAPO EKO white
End cap
Ref: 20055

ACCESSORIES

FASTENERS & MOUNTING ACCESSORIES

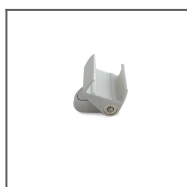

REG-PD-UV
Mounting bracket
Ref: 24270

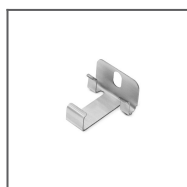

PDS-STN-90D
Mounting bracket
Ref: 24367

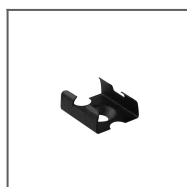

PDS Mounting
bracket
Ref: 24189

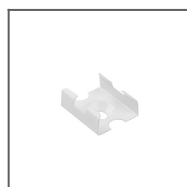

PDS Mounting
bracket
Ref: 24223

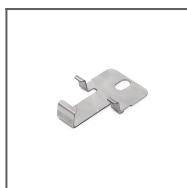

PDS-STN-ALFA
Mounting bracket
Ref: 24426

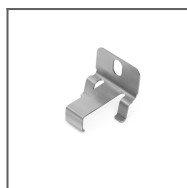

PDS-STN-90G
Mounting bracket
Ref: 24370

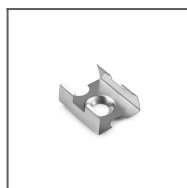

PDS-STN
Mounting bracket
Ref: 24190

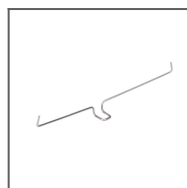

PDS Spring
Ref: 00800



ZZ Head
Ref: 42218



BZP-ZO Head
Ref: 42214



BZP-ZZ Head
Ref: 42215



BZP Head
Ref: 42213



ST Head
Ref: 42216



ZO Head
Ref: 42217



PUSZ-PRET-MR
Fastener black
Ref: 42281L9005



PUSZ-PRET-MR
Fastener silver
Ref: 42281



PUSZ-LIN-MR
Fastener silver
Ref: 42278



PUSZ-LIN-MR
Fastener white
Ref: 42278L9010



PUSZ-PRET-MR
Fastener white
Ref: 42281L9010



PUSZ-LIN-MR
Fastener black
Ref: 42278L9005



FI-8-LIN-MR
Fastener white
Ref: 42287L9010



PUSZ-PRET-MR
Fastener
Ref: 42252



PUSZ-LIN-MR
Fastener
Ref: 42258



FI-8-LIN-MR
Fastener black
Ref: 42287L9005



FI-8-LIN-MR
Fastener silver
Ref: 42287



DP-ZZ Fastener
Ref: 00651



DP-MOC-ZO
Fastener
Ref: 00646



DP-ZO Fastener
Ref: 00649



DP-MOC Fastener
Ref: 00645

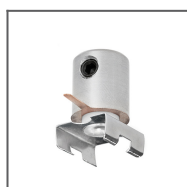

DP-MOC-ZZ
Fastener
Ref: 00647



DP Fastener
Ref: 00644

COMPONENTS FOR CONNECTING PROFILES

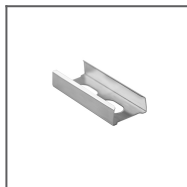

PD-MICRO
Connector
Ref: 42150

MOUNTING SETS



M3 Fastener set
Ref: 42303



M4 Fastener set
Ref: 42301



M5 Fastener set
Ref: 42302



W9 Fastener set
Ref: 42607



W10 Fastener set
Ref: 42608



M11 Fastener set
Ref: 42609



M12 Fastener set
Ref: 42610

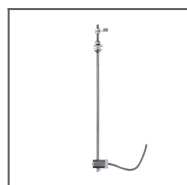

M13 Fastener set
Ref: 42611

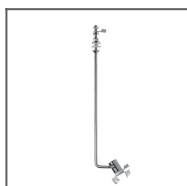

M14 Fastener set
Ref: 42612



RG-1 Fastener set
black
Ref: 42647L9005



RG-1 Fastener set
silver
Ref: 42647NI



RG-1 Fastener set
white
Ref: 42647L9010

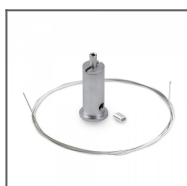

RG-1 Fastener set
silver satin
Ref: 42647GSS

SEALING COMPONENTS



6 x 1.2 Gland
Ref: 00802

MARKETING MATERIALS



Presentation set 6
Ref: 90125