

## PRODUCT DESCRIPTION

- Mounting track
- Installation in solid masonry surfaces
- Functions as a plaster guide
- Easy servicing of the lighting fixture
- Non visible aluminum elements

### FINISH :

Non anodized (raw) 

\*Custom colors available upon request

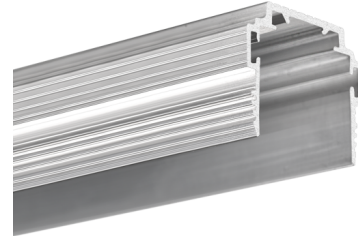

Fill empty fields

Product nr.

Fixture type

Company

Job name

Date

## TECHNICAL SPECIFICATION

### Application

- makes installation and service of lighting fixtures easy

### Mounting

- in solid surface, with mounting adhesive,
- can be easily connected into runs.

### Additional information

- TEKNIK-ZM-TK allows you to connect mounting channels into runs between the planes of walls made of different materials. For example, the mounting channel embedded in a solid masonry wall can be connected with a profile embedded in drywall (e.g. TEKNIK-ZM profile). The final effect is a line of light passing from the masonry load bearing wall to the partition wall made of drywall
- TEKNIK-ZM-TK is compatible with many profiles, e.g. LOKOM, GIZA, LIPOD, GIZA-LL
- if a profile with a height of less than 24mm is installed in TEKNIK-ZM-TK (e.g. GIZA-LL), paint the inner side walls of the TEKNIK-ZM-TK mounting channel the color of the ceiling or wall surface finish
- the TEKNIK-ZM-TK assembly channel has space at the bottom for cables and micro-connectors
- dimensions of the mounting groove in the masonry wall for the TEKNIK-ZM-TK profile: 40mm (width) x 35mm (depth)

## AVAILABLE LENGTHS

Ref. nr.	surface finish	available lengths
C1554NA_1	Non anodized (raw)	1000 mm
C1554NA_2	Non anodized (raw)	2000 mm
C1554NA_3	Non anodized (raw)	3000 mm

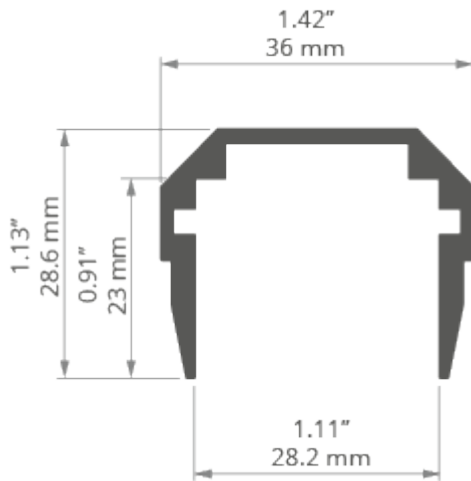
**TECHNICAL DRAWING**

**RELATED PROFILES**

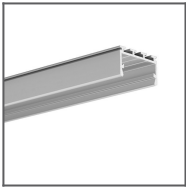

GIZA-LL profile  
Ref: C0758

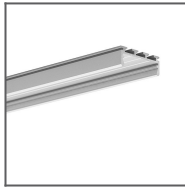

GIZA Profile  
Ref: B5556

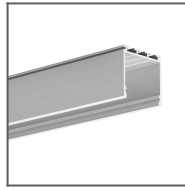

LIPOD Profile  
Ref: B5554

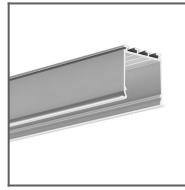

LOKOM Profile  
Ref: B5553

## RELATED PRODUCTS

### END CAPS

#### REGULAR END CAPS



TEKNIK-ZM grey  
End cap  
Ref: 24264

### ACCESSORIES

#### FASTENERS & MOUNTING ACCESSORIES



TEKNIK Latch  
Ref: 24003

#### COMPONENTS FOR CONNECTING PROFILES

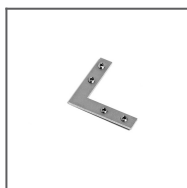

ZM-NA-90  
Connector  
Ref: 42723

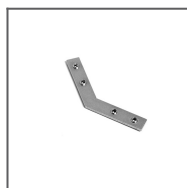

ZM-NA-135  
Connector  
Ref: 42725

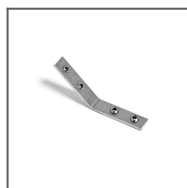

ZM-NA-PION-135  
Connector  
Ref: 42727

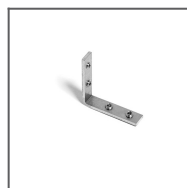

ZM-NA-PION-90  
Connector  
Ref: 42726

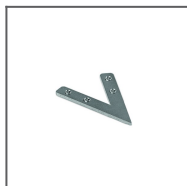

ZM-NA-45  
Connector  
Ref: 42339



ZM-NA-PION-120  
Connector  
Ref: 42321

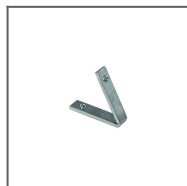

ZM-NA-PION-60  
Connector  
Ref: 42317



ZM-NA-PION-45  
Connector  
Ref: 42315



ZM-NA-180  
Connector  
Ref: 42724

#### SEALING COMPONENTS



6 x 1.2 Gland  
Ref: 00802

#### ADDITIONAL ITEMS

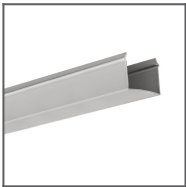

TECH-28  
protective insert  
Ref: 17168

#### MARKETING MATERIALS



Foam 70426  
Ref: 70426



Display  
P230-90176M  
Ref: 90176M